

Hobie



SAILING PARTS & ACCESSORIES



SCAN TO GO TO
HOBIE SUPPORT PAGES



SCAN TO GO TO
HOBIE PARTS LOOKUP

CONTENTS

ITEM	PAGE
LIFE VESTS / PFD	2-3
PET PFD / WET WEAR / SAFETY	4
TRAPEZE / GLOVES	5
TRAPEZE	6-7
WING SEATS / BACK RESTS	8
<hr/>	
SAILS	9-11
BATTENS / SAIL ACCESSORIES	12-13
WIND INDICATORS	14
TRAMPOLINES	15
RIGHTING	16-17
<hr/>	
STEERING / RUDDERS / TILLERS	18-19
SAIL TRIMMING / HARDWARE	20-25
LINE	26
HATCHES / BAGS	27
<hr/>	
TRAILERS, STORAGE	28
TRAILER ACCESSORIES / MAST STEPPING	29
BEACH WHEELS / CARTS	30
COVERS / BAGS	30-31
STICKERS / TOOLS / REPAIRS / MAINTENANCE	32-33
<hr/>	
HOBIE SUNGLASSES	34-37
APPAREL / HATS / ACCESSORIES MISC.	38-39
ACCESSORIES / HOBIE BOOK	

Note: Freight to dealers is not included in pricing.
 No portion of this catalog may be reproduced without the express permission of the Hobie Cat Company.
 All rights reserved. ©2021 Hobie Cat Company. Oceanside, CA 92056
 Pricing subject to change. Printed in USA

LIFE VESTS & PFDs



S6103xx (xx = size)
MEN'S SUN

HOBIE THIN-BACK by Stohlquist
Features a thin foam back design ... perfect for use with Hobie Vantage seats. This thinner back profile provides more mobility and comfort, while reducing interference with taller seat backs.

THIN-BACK S6103-6
THIN-BACK FISH S6107

FEATURES:

Thin back design works with all seat styles; Graded Sizing provides the best possible fit; Open sides for ventilation; Cross-chest cinch harness for zero ride-up; Mesh shoulders & interior panels for maximum ventilation; Adjustable shoulders, and dual forward pulls for a custom fit; Zippered front pockets offer organization; Built-in beverage holder and neoprene sunglasses sleeve; Entry grip tab at zipper base; #10 YKK zipper with non-corroding slider; Lightweight PE Foam; Type III PFD with sea level buoyancy: SM: 16 lbs, 8oz / LXL: 17 lbs / XXL: 17 lbs, 8oz

CONSTRUCTION:

- Mini Ripstop nylon outer shell
- 200 denier oxford liner
- USCG approved

SIZING:

MEN'S		WOMEN'S	
SIZE	CHEST	SIZE	CHEST
SM	30" - 40"	XSS	28" - 34"
LXL	40" - 46"	ML	34" - 40"
XXL	46" - 52"	PL	40" - 46"

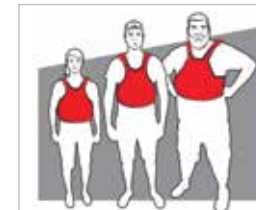

GRADED PFD SIZING

Fine tuned for each individual size, and sculpted foam footprint and foam thickness to provide a better fitting, and more comfortable PFD for people of all sizes.



S6104xx (xx = size)
MEN'S SLATE



S6107xx (xx = size)
MEN'S FISH SLATE GREEN



S6105xx (xx = size)
WOMEN'S SUN



S6106xx (xx = size)
WOMEN'S SLATE

SIZING

SIZE	CHEST
SM	33" - 39"
LXL	40" - 46"
XXL	48" - 54"



HOBIE EDGE by Stohlquist

An innovative, high mobility, low profile boating vest for kayaking, SUP, and wetsailing.

S6108xxx (xxx = size)

FEATURES:

Ergonomic WRAPTURE™ shaped torso; Adjustable shoulders, 4 side pulls, and front waist buckle closure; Low cut, offset front-zip entry; Large arm openings for unrestricted whitewater and SUP paddling; Contoured padded shoulder straps; High visibility 3M™ reflective accents; Roomy, top loading front pocket for secure storage and easy accessibility; Mesh sides for maximum ventilation; Mini-Ripstop nylon shell & 200 denier oxford liner; Type III PFD with sea level buoyancy listed: SM: 15 lbs, 8oz / LXL: 16 lbs, 8oz / XXL: 17 lbs, 8oz

CONSTRUCTION:

- Mini Ripstop nylon outer shell
- 200 denier oxford liner
- USCG approved

SAFETY TIP

LIFE VESTS: Get a good, comfortable life vest and WEAR IT! A life vest does you little good stored on your boat, especially if you get tossed into the water and away from your boat. Accidents happen and by their nature, they happen when you are not prepared. A life vest can keep you afloat until you can rescue yourself or you can be rescued by others. In the worst cases when injuries or cold water are involved, your life vest can make all the difference! Be sure everyone onboard your boat wears a life vest too! Pass the word! Federal law now requires that all persons below the age of 13 must wear a life jacket while aboard a boat.



HOBIE INFLATABLE PFDs

Light weight and comfortable. Ready when you need it, manual CO2 inflation or by mouth inflator allows for swimming, wading and intentional immersion. **NOTE: AIR SHIPPING RESTRICTIONS CO2 / DANGEROUS GOODS**

Coast Guard Approved Type III Nearly twice the buoyancy of USCG foam PFD Shortened slim fit shell for improved comfort when pedaling a Mirage kayak Mesh Yoke Back Strap for breathability and preventing ride-up Large Easy Access Storage pocket for increased storage capacity Inflates manually for flotation only when it's desired D-ring for accessory attachment Accessory attachment straps Interior pocket for holding spare CO2 inflation cylinder Fits 30-52" chests and users 16+ years Included 24g CO2 cylinder provides 26 lbs. of flotation

- S6782BL** PFD INFLATABLE BLUE - 24g
- S6782GR** PFD INFLATABLE GREEN - 24g
- S6782RD** PFD INFLATABLE RED - 24g
- S6782TN** PFD INFLATABLE TAN - 24g
- S6779R** PFD INFLATABLE REARM KIT 24g



HOBIE INFLATABLE BELT PACK PFDs

Belt carried PFD designs are cooler and more comfortable than typical PFDs. Functional design for multiple types of water sports from fishing, kayaking, sailing to stand up paddling (SUP). USCG Approved Type III PFD, approved for use by persons 80 lbs and 16 years of age or older. Size: Universal Adult Size. Durable ripstop nylon pack. 2" wide, adjustable, nylon waist belt. Includes (1) CO2 Cylinder and instructions.

16g offers Buoyancy 16.5 Pounds. Slim fit. **NOTE: AIR SHIPPING RESTRICTIONS CO2 / DANGEROUS GOODS**

- S6783BL** PFD BELT PACK BLUE 16g
- S6783YL** PFD BELT PACK YELLOW 16g
- S6780R** PFD INFLATABLE REARM KIT 16g

HOBIE INFANT/CHILD/YOUTH VESTS

These are easy to adjust for different small sized crews.

- (Lime Green)
- S6771CLG** LIME 30-50#
- S6771ILG** LIME <30#

- S6771YLG** LIME 50-90#





SIZING:

SIZE	WEIGHT	COLLAR	BODY GIRTH
XS	12 lbs.	8" - 12"	13" - 17"
S	12 - 24 lbs.	10" - 14"	15" - 21"
M	24 - 60 lbs.	13" - 19"	18" - 30"
L	60 - 90 lbs.	18" - 26"	24" - 36"
XL	90 - 120 lbs.	22" - 30"	30" - 42"

HOBIE FIRST AID KIT

Waterproof 3600 Plano box with essential first aid items.
72020078 HOBIE FIRST AID KIT



SAFETY WHISTLE

A whistle can save your life! Keep one attached to your PFD in case of onboard emergency. Alert approaching vessels. Alert other boaters or people ashore that you need help.

MK0053 SAFETY WHISTLE



ANCHOR KIT

Folding 3 lb anchor, bag and 60 feet of line.
80035A ANCHOR



HOBIE PET PFDs

You can now take your best friend with you safely and in Hobie Style! Added flotation as a swim assist and grab handles, so you can help them back aboard more easily. Adjustable fit, leash attachment, side pockets, grab handles and soft foam undercarriage support. Happy days for dogs!

FEATURES:

Tri segmented soft foam design; Foam supported Ripstop-nylon collar; Dual cargo pockets (S, M, L, XL); Dual integrated grab handle design (M, L, XL); Soft foam undercarriage support chassis; Integrated leash attachment

- S9000XS** PET PFD XS MANGO <12#
- S9000SM** PET PFD SM MANGO 12-24#
- S9000MD** PET PFD MD MANGO 24-60#
- S9000LG** PET PFD LG MANGO 60-90#
- S9000XL** PET PFD XL MANGO >90#



TELESCOPING PADDLE

Measures just 20" in closed position (45" when fully extended). Lightweight, anodized aluminum shaft corrosion resistant design. Floats too! 6 1/2" wide blade will fit into an 8" hatch opening.
3091 TELESCOPING PADDLE



FULL "AUTO" HARNESS

For those looking for added back support and comfort while on the trapeze. Great for spending lots of time on the wire. New spreader ratcheting feature allows easy adjustment of harness around hips as well as quick release feature to get out of harness quickly. Crotchless design with neoprene leg straps, adjustable lumbar support, neoprene covers over side buckles, and reinforced patch on the seat. Comes with ratchet adjust 10" stainless spreader bar that can only be used with this harness. Colors may vary.

1476xx Full "Auto" Harness

(xx = size) (Limited to SM, XL)



CONVERTIBLE HARNESS

"Converts" easily from a half harness to full harness with the addition of shoulder straps (included). The all around harness for both racers and recreational sailors where comfort, support and mobility are key. For the recreational sailor the half harness has enough back support to keep you comfortable on the tramp or the trap. For the racer, just add the shoulder straps for those long days out on the trapeze where extra back support is needed. Extra stiff back support, padded leg straps/shoulder straps, neoprene covers over buckles and a 10" stainless spreader bar. It all adds up to keeping you comfortable and having fun on the water. Shoulder straps included with harness. Colors may vary.

1478xx CONVERTIBLE HARNESS

(xx = size) (SM/MD, LG, XL)



SKIPPERS HARNESS

The harness for both racers and recreational sailors where comfort and mobility on the trampoline are most important. For the sailor who spends less time on the trapeze or prefers to "sit up" rather than lean out more. Unique leg strap design combining neoprene and webbing to eliminate chafe. Neoprene covers over side buckles and a 10" stainless spreader bar.

Reinforced seat. Colors may vary.

1488xx SKIPPERS HARNESS
 (xx = size) (SM, MD, LG, XL)



HOBIE GLOVES

Protect your hands while increasing your grip strength. Gloves add grip strength on lines which can ease up on the amount of force you need to exert. Available in small, medium, large & extra-large. (xx = size)

3188xx HOBIE GLOVE



RONSTAN GLOVES

Double thickness palm and fingers for protection and grip. Mesh panels for flexibility, comfort and quick drying. Low cut neoprene wrist band. Sticky gloves reduce fatigue by minimizing the physical effort required to hold ropes.

(xx = size XS/SM/MD/LG/XL)

RF4851xx Three Finger Glove



RF4850xx Short Finger Glove

TECH TIP!

SAILING GLOVES: Get a good grip on your lines. Sailing gloves absorb and distribute the sheet rope load, as well as protect your skin from wear and tear. Lower cost gloves are fine for the casual sailor. The more rigorous the sailing conditions the more a higher quality glove is required. Our high end gloves are double thickness leather in high wear areas, padded to spread out the squeeze load on your hand and reasonably easy to get on and off.



COATED TRAP WIRE SETS

Highest quality aircraft stainless wire coated with UV tolerant black or white vinyl coating for all of our wire products. Molded nylon handles are installed at the right place for easy in and out maneuvering. Also available in kits which include the trapeze shock cord.

- 1471B H16,17,SPORT PAIR-BLACK
- 1472B ABOVE w/ SHOCKCORD (16 only)
- 1473B H18 PAIR (1 SIDE)-BLACK
- 1474B ABOVE w/ SHOCKCORDS
- 1475B H14 PAIR-BLACK
- 1476B ABOVE w/ SHOCKCORD
- 1478B GETAWAY PAIR-BLACK

WAVE / GETAWAY TRAPEZE KITS

Add a trapeze system to your Hobie Wave or Getaway. Complete with wires (pr), return bungee system, lines, blocks, locks and dog bones. Just add a trapeze harness and you are flying! Wave kit includes adjustment lins with internal shockcords and hull attachment hardware.

- 38140001 WAVE TRAPEZE KIT
- 37140001 GETAWAY TRAPEZE KIT

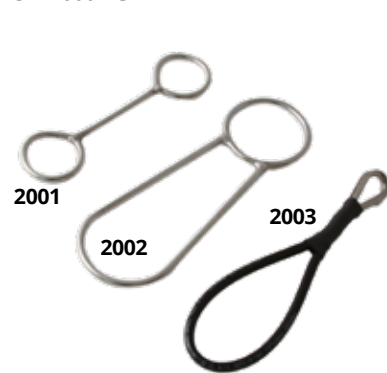

TRAPEZE DOGBONES

These dogbones feature high grade 316 stainless steel with welded construction for superior strength.

- 2001 STANDARD
- 2002 KEYHOLE SHAPE
- 2003 FLEXIBLE DOGBONE



HARKEN MICRO FIDDLE BLOCK

Superior quality Micro Fiddle Block with V-Jam cleat from Harken. For use with 7/32" to 5/16" (5mm-8mm) line to make adjustable trapeze system.

H244 Each

DOUBLE ADJUSTABLE TRAPEZE

Adjust the level of the entire system, ring and handle. Always have the trapeze "T" handle at the proper comfortable to reach level. Crew can move fore and aft to extremes and maintain efficient and comfortable trapezing level. Bungee gives constant upwards pull on trapeze ring to ensure that you stay hooked up. Stock trapeze wire must be shortened by approx. 8". Order trapeze rings and bungee separately.

1204 Kit



J & H HANDLES

Open design combination dogbone/trapeze handle makes getting hooked and unhooked very simple. Choose a different color for the skipper and crew for easy identification.

- 2004BLK PAIR-BLACK
- 2004WHT PAIR-WHITE

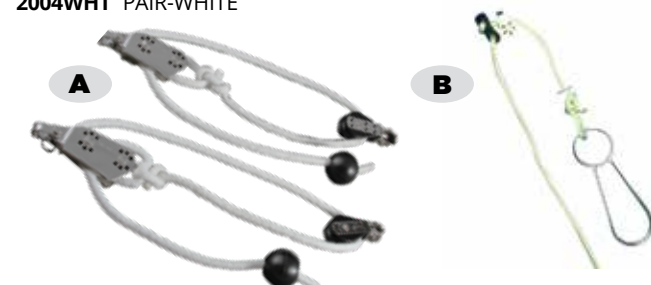

A. DELUXE ADJUSTABLE TRAPEZE RIG

The original trap rig. Adjust your position while you are out on the wire. V-Jam pulley system allows you to compensate for that puff or lull in the wind without coming in off the wire. Comes complete with all blocks, ropes, and swivels needed for one pair.

1203 w/o DOGBONES

B. STANDARD ADJUSTABLE TRAPEZE RIG

The standard kit includes blocks with removable sheaves, rope, rope locks and stop washers. Can be purchased with #2002 dogbones or without dogbones (for possible use with J&H Handles.)

- 3101 w/ DOGBONES
- 3102 w/o DOGBONES



MOLDED TRAPEZE HANDLE

Strong and comfortable molded grips are contoured to fit the hand. Wire guide shank keeps wire from cutting between the fingers. This is the "standard" handle on all wires.

2011 Each

REPLACEABLE TRAPEZE HANDLE

This simple, rubber padded, all aluminum handle can be installed on any 3/32" wire without disconnecting anything. Just screw the 2 halves together and it's ready to use.

2010 Each



RAIL RUG

Provides excellent footing when out on the trapeze. Kit includes a high quality grade of carpeting which absorbs less water, keeping weight down and reducing mildew. Also included in each kit; industrial grade contact cement (much better than the hardware store variety), brush and easy to follow instructions. For all catamarans.

- 1671BLK H14/16-BLACK
- 16703 CONTACT CEMENT-PT



NEOPRENE RAIL KITS

Provides excellent footing while out on the trapeze and cushions the non-skid areas. Eliminates abrasion on your skin or clothing because it sheds sand. Zero water retention. Made out of 1/8" thick knobby black neoprene. Kit includes industrial grade contact cement, brush, and instructions for easy installation on any boat. Race strips are for hull decks rear of trampoline frame. H16 kits are full wrap around as used in Worlds boats.

- 16706 H14 / H16 KIT
- 16707 RACE STRIPS-PAIR
- 16708 H18 KIT (H18 Die Cut - Shown Above)

TECH TIP!

Trapezing: While sitting on the edge of the boat, attach the trapeze dogbone to the trapeze hook on your harness. Grab onto the trapeze wire's handle with your forward hand. Place your other hand on the hull behind you. Using your hands for balance ease yourself off the side of the boat and place your forward foot on the rail. Push yourself away from the boat with your rear hand and forward foot till you can place the rear foot on the rail. Stand on the rail of the boat with your weight on the trapeze wire. Keep your forward leg more ridged and aft leg slightly bent. This position will help keep you from falling forward.

While learning to trapeze, beginners should set their trapeze height just at the rail level or slightly above. This will make it easier to get in and out. Keep your legs spread several feet apart for balance. As you get used to the feel of trapezing you can begin to lower your trapeze height and move your legs closer together. Once you become an expert on the trap wire, your proper body position should be parallel to the deck with your feet right next to each other.



REMOVABLE SHEAVE TRAP RIG BLOCK

This is the block we include in our basic trap rig kits. No need to cut wires to install this block. Simply remove the clevis pin that acts as the sheave axle, slide the sheave out of the frame, place the frame through the trap wire thimble and reinstall the sheave.

3103 Each



TRAP STAY

An easy answer to wandering wires and "who's whose" confusion on the Hobie 16. Mount these little keepers under the side rails and drop the shockcord in. Works great to keep everything in its place.

176 Pair



ROPE LOCK

Use on trapeze rope to make your trapeze system adjustable.

61530000 Each

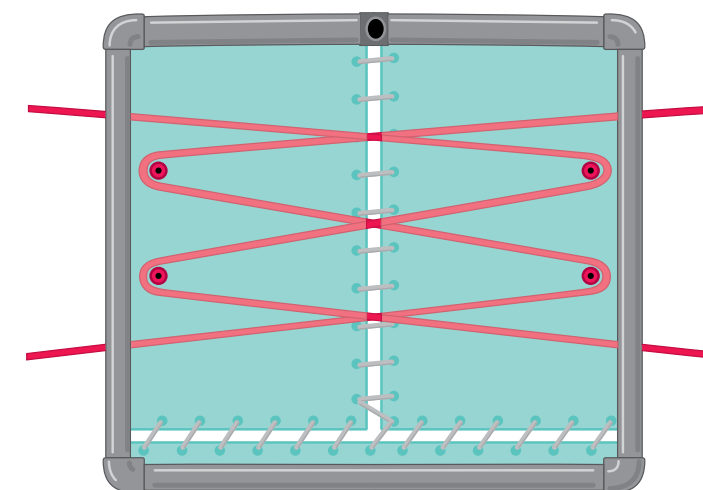

TRAPEZE RIG RETURN SYSTEM

Custom system with double-length shockcord reduces the unpleasant forward pull when you're trapped out off the stern on a reach. It also prevents breakage of the shockcord when you stuff a lee bow and the crew takes a spin around the forestay. All required hardware is included.

14709 H16 KIT

PERFORMANCE COMFORT



GETAWAY WING SEATS

These are perfect for lazy day sailing, relaxed hiking out on your Hobie Getaway or for high performance fun. Turquoise vinyl mesh covers aluminum extrusions that are contoured to make a very comfortable back rest or seat. Remove two quick pins per side and they rotate in for trailering.

37001020 GTWY SUS MESH WING ASSY, TURQ =<2016

37001030 GTWY SUS MSH WNG ASSY 17-19 GR

37001035 GTWY SUS MSH WNG ASSY 20 GREY

37971058 REPLACEMENT COVER - (PRE SUS) TURQ MESH <=2016

37977058 REPLACEMENT COVER - (PRE SUS) GREY MESH 2017+



HOBIE WAVE

WAVE BACK RESTS

These simple to install Back Rests are perfect for lazy day sailing on your Hobie Wave. The last word in sailing comfort. They plug into the front and rear cross beams. On or off in 3 minutes or less.

38040011 BACK REST, SET (BLUE)

38040012 BACK REST, SET (GREY)

38041001 REPLACEMENT PAD COVER (BLUE)

38041002 REPLACEMENT PAD COVER (GREY)

8020181 FAST PIN (EACH) FOR QUICK RELEASE OF BACK RESTS. FOUR REQUIRED. SOLD SEPARATELY.

NOTE: ADDITIONAL FREIGHT CHARGE ITEMS

Items shown on this page will incur additional freight charges from the factory that are not included in pricing shown.



Bravo
MARTINIQ

BRAVO

90990021 SAIL, BRAVO MAIN SEABREEZE

90990022 SAIL BRAVO 3.8 OZ-MARTINIQ

WAVE

38991000 SAIL, WAVE MAIN "V" WHITE

38991079 SAIL WAVE MAIN "V" MARTINIQ

38991050 SAIL, WAVE MAIN "H" RESORT WHITE

38992010 SAIL, WAVE JIB WHITE

38992007 SAIL, WAVE JIB YELLOW

38992072 SAIL WAVE JIB ORANGE (25 sq ft)

GETAWAY

37991077 SAIL GETAWAY MAIN "V" MARTINIQ

37992072 SAIL GETAWAY JIB ORANGE

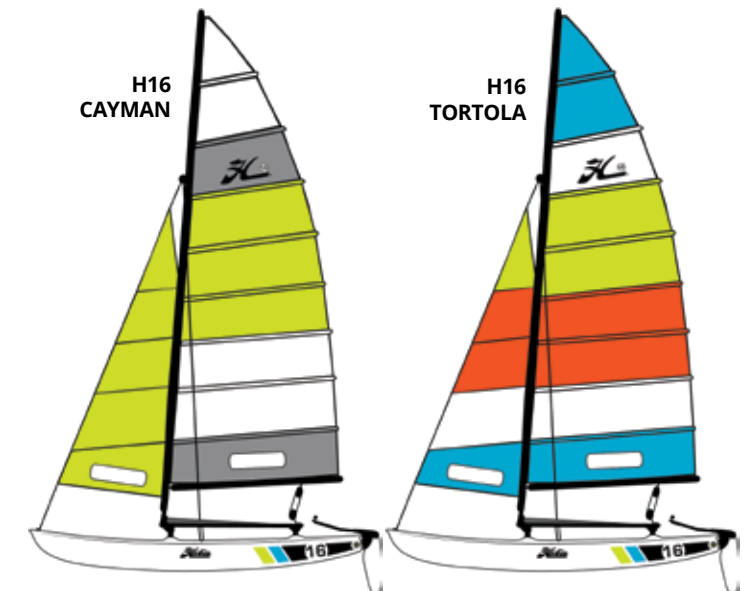

H16
CAYMAN

H16
TORTOLA

HOBIE 14

10990010 SAIL, H14 MAIN, WHITE

10992511 SAIL, H14 JIB, WHITE

HOBIE 16

20991011 SAIL, H16 MAIN, WHITE

20991089 SAIL H16 MAIN TORTOLA

20991090 SAIL H16 MAIN CAYMAN

20992010 SAIL, H16 JIB, WHITE

20992089 SAIL H16 JIB TORTOLA

20992090 SAIL H16 JIB CHAR (CAYMAN)

20992310 SAIL, H16 JIB, WHITE (VELCRO*)

VELCRO* = Velcro closure / tensioned battens (less halyard hangup)

HOBIE 18

60991011 SAIL, H18 MAIN, WHITE

60992011 SAIL, H18 JIB, WHITE

SEE PARTS LIST FOR ALL OTHERS



HOBIE WAVE JIB KIT

Bring your Wave sailing up a level. More sail area (jib adds 25 sq ft) equals more speed and performance in light wind conditions. The Wave jib accelerates learning and encourages participation of your crew in sailing. Our jib hardware kit comes complete with bow spreader pole, all the nuts, bolts, and blocks required. Order Jib separately.
38999001 WAVE JIB HARDWARE KIT
38992010 WAVE JIB, WHITE
38992007 WAVE JIB, YELLOW
38992072 WAVE JIB, ORANGE

JIB KIT SPARE PARTS

38999021 BOW SPREADER POLE ONLY
38120041 TANG FOR BOW SPREADER POLE



HOBIE 14 TURBO KIT (JIB & FURLER)

Add Turbo power and enjoy the excitement of trapezing from the 14 with the complete Turbo kit (comes complete with trapeze and jib sheeting hardware). A dolphin striker is required for trapezing. If your boat is pre-1982, order the upgrade kit for new length shrouds, chain plates and tramp jib grommets. Order jib separately.
80200000 TURBO KIT w/ HOBIE FURLER
10992511 WHITE JIB

! TECH TIP!

ROLLER FURLING JIBS: Just roll the jib up when you come into the beach or de-power if it gets too windy. Want to fly a spinnaker? The furling systems work great for easy spinnaker flying. A roller furling jib system can increase the life of your jib by avoiding flogging the jib material while on the beach or between races. Allows you to store the boat without lowering the jib (jib "snorkle" cover suggested). Kits available for the Hobie 20, 17, 16, 14.

HOBIE JIB FURLER SYSTEMS

Just roll the jib up when you come into the beach or de-power if it gets too windy. Speed, excitement and convenience all rolled into one!

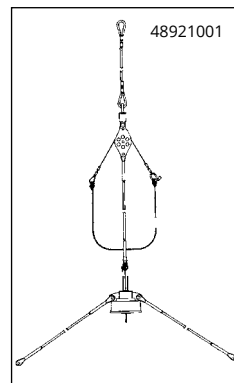

HOBIE 16 FURLER KIT

Order a new furling jib separately or requires a re-cut of the standard jib.
8001 KIT w/ HOBIE FURLER
8002 WHITE FURLING JIB

HOBIE 16 FURLING GENNAKER SYSTEM

Increase your off-the-wind sailing performance with this pole-mounted furling gennaker. A large reaching genoa attached to a furling drum mounted on a pole which moves the sail area further forward like a spinnaker, but furling for easy deployment and retrieval.
20999201 POLE, FURLER, HARDWARE AND WHITE GENNAKER

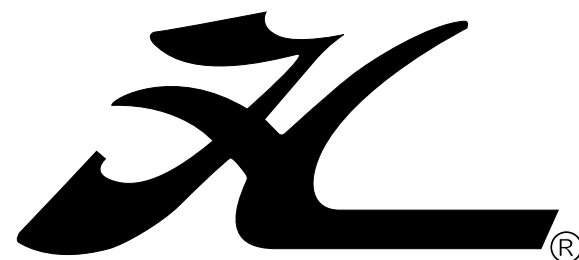

SPINNAKERS

SPINNAKER SYSTEMS

Quick setup, ease of use, and maximum performance were just a few of the design criteria. Our spinnaker kits provide better sail control with fewer lines. The Spinnaker Pole and Rig Kit contain all the equipment and lines to control hoisting, setting the tack and sheeting the Spinnaker. Just pull on the halyard...the sail is hoisted and the tack is hauled out to the pole end!

HOBIE 16 / GETAWAY* TRUMPET SNUFFER SPINNAKER SYSTEM (*GETAWAY USE REQUIRES SOME KIT MODIFICATIONS, INSTRUCTIONS ONLINE)

20999020 POLE, SNUFFER, SPINNAKER & HARDWARE
F16032110 SPINNAKER REPLACEMENT (COLORS VARY)

HOBIE WAVE

38999000 WAVE POLE & HARDWARE KIT ONLY
38999052 WAVE SPINNAKER (COLORS VARY)



HOBIE GETAWAY



HOBIE 16 / SNUFFER SYSTEM



HOBIE WAVE

! TECH TIP!

SPINNAKERS: Flying a spinnaker is one of the great thrills of sailing. And one of the great challenges for both skipper and crew. Spinnakers increase downwind speed while actually creating lift at the bows! Few things compare to the thrill of running off the wind under a huge and colorful spinnaker! Spinnakers require special rigging. A survey of the products on these pages will give you a good idea of the options available.

UNIVERSAL BATTENS

Availability of the correct batten has often been a problem. The various models of Hobie Cats all use different batten and taper lengths. In earlier years, each model Hobie used a different color batten. The battens were all the same specification, just a different color. We now stock only white sail battens for all models.

Complete batten sets, cut and tapered to specification length are available for some models. Individual battens are filled from stock as shown in the following table. Batten numbers start from the bottom batten in each sail (#1). Battens are trimmed by purchaser to exact length. Stock batten lengths are shown in the illustrated Hobie parts pages. (T)=Tapered

82010001 BATTEN (max 107 7/8", min 87 5/16") *not tapered*

82020001 BATTEN (max 82 3/8", min 72 1/8") *not tapered*

82030001 BATTEN (max 90 1/8", min 46 1/8") 27" *taper*

82040001 BATTEN (max 42 11/16", min 39 1/16") 27" *taper*

82060001 BATTEN (max 100 9/16", min 67 7/8") 27" *taper*

82070001 BATTEN (max 67", min 51 3/4") *not tapered*

82080001 BATTEN (max 43 3/4", min 24 1/8") *not tapered*

	82010001 107 7/8"	82020001 82 3/8"	82030001 90 1/8"(T)	82040001 42 11/16"(T)	82060001 100 9/16"(T)	82070001 67" (J)	82080001 43 3/4"(J)
WAVE		1,2,3				4	5
H14	1,2		3,4,5	6			
GETAWAY	1,2		3,4,5,6,7				8
H16M	1,2,3,4	5,6	7	8			
H16J						1,2	3,4
H17			3,4		1,2	5	6
H18	1,2,3,4,5		6,7,8	9			10
H18SX	1,2,3		8		4,5,6,7		9
H21SE	1,2,3		4,5,6				7

TECH TIP!

SAIL CARE: At the end of the day most cat sailors roll their sails on the lower batten or around the boom. If you do, roll your sail loosely. Any sharp bends in the sail cloth break down the resin coating on the cloth. This weakens the cloth leading to premature stretching or pin size holes that will grow. You can lengthen the life of your sails with careful handling and by using some of the special accessories we offer. The various tapes and sleeves we offer are all intended to protect the sail from sharp edges and abrasive areas on the boat that wear away at the sail's fabric until suddenly there's a hole and next a tear. It's never too late to slow down wear and tear.

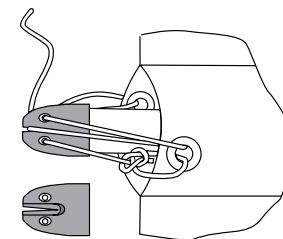

HOBIE CAT LEACH & LUFF CAPS

Release the batten tension whenever you store your sails. This will prolong the life of your sails. Luff caps and adjustable leach caps are made of high strength, ultra-violet tolerant Delrin®. No knots to tie or untie. Tension adjustment lines not included. Sold individually. 4:1 mechanical advantage allows finer adjustment than does Trentec 2:1 caps.

- 11323000** MAIN LEACH
- 21333000** JIB LEACH
- 11322011** MAIN LUFF TIP

BATTEN CAP SETS

- 1521H** HOBIE 14/17 SET
- 1522H** HOBIE 16 MAIN SET
- 1531H** HOBIE 16 JIB SET
- 1523H** HOBIE 18 SET



TRENTEC LUFF CAPS

Prevent "poke through"! These Trentec caps slip over the luff (front) end of your mainsail battens to increase the life of your sails and of the batten-pocket protectors. Each cap is molded at the angle to match the angle at which the batten meets the luff.

- 1562** H16 MAIN KIT
- 1563** H18 KIT
- 1566** H16 JIB KIT



SPREADER BAR END COVERS

Smooth and resilient vinyl spreader bar end covers protect the jib luff from wear and tear on cotter keys and sharp edges. A real sail-saver. **3262** PAIR



SAIL CHAFE PROTECTOR SET

From Harken. A split roller predrilled to fit up to 3/16" diameter wire. Replaces diamond wire rollers. **H285** SET



SAIL REPAIR TAPE

Don't get caught with your sails down! Extra strong, Rip Stop white tape for temporary on-the-spot repairs to torn sails, canvas, even foul weather gear. Keep a roll in your toolbox for emergencies. **1662** 2" x 25' ROLL



JIB PROTECTOR KIT

Install hard plastic covers specially designed for cotter keys and Hobie 18 and 20 spreader bar ends. No slitting or taping required. **1512** H18 Kit



SAIL REPAIR KIT

Takes care of emergency repairs to sails and trampolines. Kit includes 3 different weights of thread, 3 sizes of needles, and 6" x 6" white sail cloth. **1665** KIT



TECH TIP!

WIND INDICATORS: When sailing downwind, without a bridle fly, you can't gauge apparent wind direction without looking up and taking your attention off the action (boats crossing) on the water. The light weight indicators are most suitable in moderate and stronger wind conditions. Not severely affected by wave action, they work well tacking downwind. They are both durable and sensitive. The heavier Telo Cat is the most durable. It stands up to crashing waves sailing in rough conditions. A bridle fly is very effective when sailing off the wind, especially in light and moderate air, but will also give you indication of wind shifts on any point of sail.

CM7703

HOBIE BRIDLE FLIES

Durable Mylar wind vane with excellent light to moderate air response. Adjust your sails to the apparent wind angle. A must for best downwind sailing performance. Stainless steel mounting shaft. Quick removal for trailering.

- CM7703 STD BRIDLE VANE
- CM7704 REPLACEMENT VANE
- CM7705 HOBIE FURLER ADAPTER



CM7705



CM7704

TELO CAT WIND VANE

Tough molded plastic vane. Rugged heavy duty stainless steel shaft with Teflon bearings. Tacking arms can be set to desired vane angle for optimum performance setting. Easy removal—no tools required. Fits Hobie 14/16.

- 377 TELO CAT
- 378 VANE ONLY



AIR-FLOW TELS

Trim your sails for optimum performance. Attached air flow over sails is critical. Air flow directions are indicated by these tell tails. Made of light weight rip stop nylon (Red / Green). Attaches to sails with waterproof adhesive disks.

- 334 SET OF 14

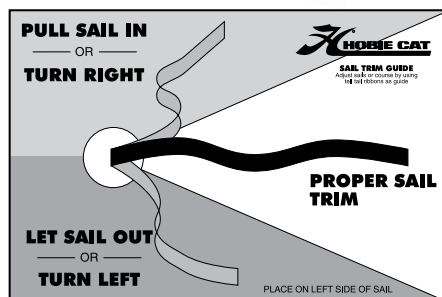
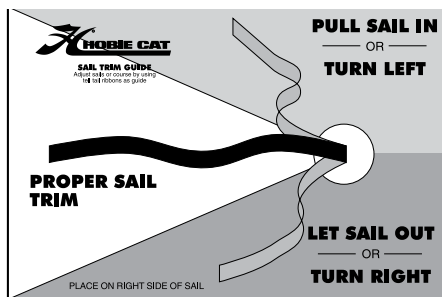

HOBIE TRAMPOLINES

All of our HOBIE trampolines are heat welded rather than stitched for the ultimate in longevity and easy maintenance. There is no potential of UV degradation of thread or loose thread unraveling an entire seam. This is a HOBIE exclusive, longer lasting by far!! All include halyard pocket. Note: Hobie Class Association racing requires the Hobie Cat factory supplied trampoline. See parts Guides and parts list for trampolines & available color options.

TRAMPOLINE DOUBLE GROMMET KIT

Hobie Cat doubled the number of grommets across the rear of the trampoline in 1983 to reduce stress and strengthen the trampoline. This kit includes 24 spur grommets and installation tools. Buy an additional 24 grommets to do the center lacing.

- 2061 COMPLETE KIT
- 2062 24 GROMMETS



TRAMP LACING KIT

Many sailors prefer lacing their trampoline with shock cord. This kit includes three pieces of 3/8" nylon covered black coated nylon shockcord and 12 clamping rings. Fits the H14, 16, and 18. Not shown.

- 2064 KIT

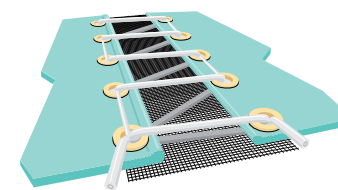

MAINSHEET OVERBOARD PREVENTER

This neat little piece of mesh laces into the existing tramp grommets, filling the center gap that the mainsheet is forever falling through. Existing lacing does not need to be undone. Kit includes line for lacing the preventer.

- 2067 66 INCHES



HALYARD POCKET ON ALL TRAMPOLINES

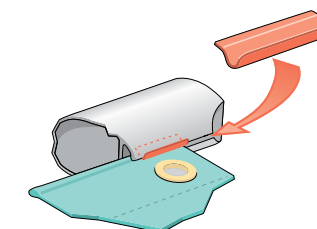

TRENTEC™ TRAMP CLAMP™

Prevents trampoline from pulling out of aluminum extrusion. Increases trampoline life. Minimizes chafing of the trampoline at the critical stress points.

- 2066 SET



TRAMPOLINE DRINK HOLDER

You can add drink holders to your trampoline too! Requires a hole cut into the trampoline and stitching. Can be done by a sail loft or upholstery shop.

- 1125 Drink Holder



EASY RITE

Internal shock cord recoils this righting line automatically. Made from 1/2" hollow braid line with internal shockcord. It requires no blocks or shackles. Installs in minutes without tools. Also functions as crew safety line. Our best selling righting system.
30105 H14/16/17
30106 H18/21
30108 H20
30109 GETAWAY

EASY UP

Favored Hawaiian style righting line system and trapeze safety line. (H14/16 only.) Retracts fully—it's there when you need it and out of the way when you don't. No tools required to install.
30101 H14/16
30102 H18

RIGHTING BUCKET

Simple, easy to carry, and easy to use. Comes complete with no-rot canvas bucket, premeasured line, shoulder pad (not shown) and snap. The righting bucket holds as much as 150 pounds of water to assist your body weight to right your catamaran.
30107 KIT



ANTI PITCH POLE HYDRO FOIL

A simple bow plane that attaches to the bow tang bolt. As the bow starts to dive the bow plane's 55 square inches of surface comes in contact with the water and halts the submerging of the bow before the deck goes under water. Easy to install or remove for racing. Makes sailing a lot more fun for the recreational sailor.
30110 H14/16 PAIR



RESCUE STEP

"How do I get back in if I fall out?" The RescueStep features quick and easy installation and operation for vessel re-entry assistance, righting an overturned kayak and can also be used to tow or portage your kayak. Its compact size makes it easy to bring along anywhere you need it.
72020092 RESCUE STEP KAYAK
1266 RESCUE STEP BOAT

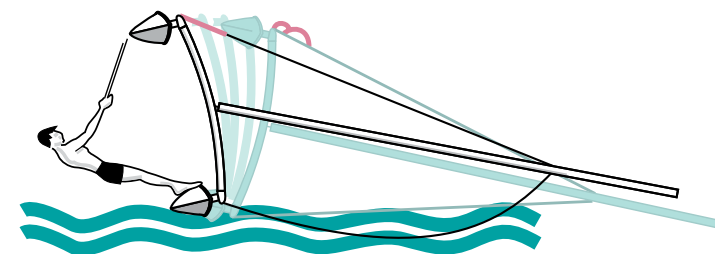

THE UPRIGHT SOLO RIGHTING SYSTEM

The Upright installs easily. No holes to drill, no measurements are needed. Attaches in five minutes to the existing shroud adjusters with a pair of pliers. Racing rules allow carrying the Upright for emergencies, but it may not be used while racing. The Upright is designed for a single reason, to make sailing your small catamaran safer.
1263 H16

SHROUD EXTENDER

Tension and de-tension shrouds easily for the "perfect" rig tension. Use in conjunction with "shroud extending" righting systems for complete re-tensioning while out on the water. Requires shrouds be shortened. Check class rules for racing.

10049 EACH



TECH TIP!

RIGHTING YOUR HOBIE: On that reach...flying through the air and water then...WHAM!!! Your Hobie Cat has forced you to swim instead of sail. Not really what you had in mind? If you have planned ahead you will be up and sailing again quickly. Whether sailing single handed or with a few friends, righting your boat can be quick and easy...

First, preventing your mast from becoming one with the bottom, or "turtling" is a priority. We at Hobie have designed mast floats to help keep your Hobie Cat from becoming a 'mudhen'. The floats attach to the top of your mast and will prevent the mast tip from sinking.

The next objective will be to get back to sailing! Righting systems vary a bit, but the theory is the same. A line is attached to your Hobie, thrown over the hull in the air and then weight (yours and or your friends) is used to lever the boat back to an upright and sailable position.

After you have checked that everyone is OK, turn your hulls and mast into the wind (see diagram) and uncleat your sails. You and your friend now need to congregate on the hull that is in the water. Grab the righting line, lean away from the trampoline and get as close to the water as you can. Try to stay out of the water. If you don't have enough body weight to right the cat we have the Righting Bucket! Just attach it to the boat, with the hook that is provided, throw over the upper hull and fill the bucket with water! With the bucket strap over your shoulder, lean your weight out from the boat. The bag comes clear of the water and up the cat will come!! Grab the dolphin striker or crossbar as it comes up, climb aboard, sheet in and GO!

Tipping your Hobie over can be a great way to cool off and enjoy the water... try it! It's excellent practice for when you weren't planning to go for a swim but your Hobie decided that you needed to cool off!

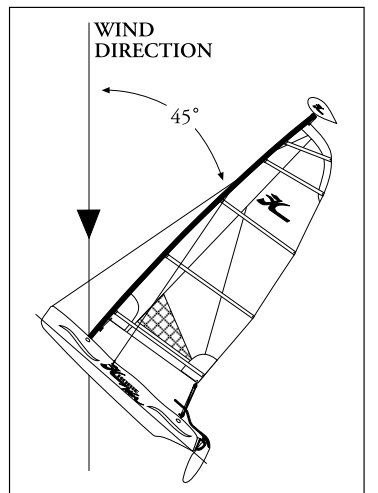

MAST FLOAT "BABY BOB"

(Standard on the Wave) Designed by the Hobie Cat team to offer the safety and security of mast head flotation while limiting the resistance (drag) through the air. If you capsize, the Hobie mast float can give you the time you need to prepare to right the boat without the worry of going turtle (mast straight down). This also helps prevent damage to your rig and sails that can be caused if the mast comes in contact with the bottom when capsized. Great for Hobie 14 and Hobie 16 as well as others with mast head castings capable of bolting in a similar fashion. It is fixed in position to the mast head and rotates with the mast. Displaces 32 pounds of water and measures 1/2 cubic foot in volume. Bracket mounting allows easy removal for racing or trailering. Kit includes mounting brackets and fasteners.
30115 WAVE, H14, H16



MAST FLOAT "MAMA BOB"

Offers more flotation volume while using the same bracket mounting system as the Baby Bob shown above. Displaces 59 pounds of water (just under 1 cubic foot in volume). Mama Bob has nearly the same vertical dimension as the Baby, but it is wider. More volume further inhibits a boat from going turtle when capsized in rough and windy conditions. This is standard on the Getaway due to both weight and trampoline area which pushes the mast downward with more wind force when capsized. Extra volume, extra safety margin! Kit includes mounting brackets and fasteners.
30119 GETAWAY



UNIVERSAL MAST FLOAT

"Mama Bob" float incorporating a universal attachment system to fit a wider variety of mast configurations. This is a shaft mounting system originally conceived for the Hobie 21 Sport Cruiser. Can attach to any mast. This streamlined float is shaft mounted to the side of any mast and is easily removed for racing or trailering. This float is contoured and held in alignment with the mast for minimum drag while sailing. Includes shaft mount hardware and fasteners.
30112 FITS ALL CATS

EPO3 RUDDER BLADES

This third generation rudder the EPO3 combines the original shape of the EPO2 rudder with an improved trailing edge. We developed the EPO3 rudder blade as the next generation performance rudder blade for the 14, 16, 17, 18 and 20. With this proven foil shape and a fine trailing edge, the EPO3 offers reduced cavitation with smoother, more forgiving control. The EPO3 rudder is stiff where it counts due to its hand laid fiberglass construction incorporating extra cloth for longitudinal stiffness. We have placed extra glass in all the right places to ensure that it is tough enough for the most demanding sailors using extreme mast rake. You will experience supreme performance and handling not found with other rudder blades. White EPO3: Gucci looks, stiff and light weight.

20490030 EPO3 RUDDER BLADE - EACH



DIE CAST GUDGEONS

Standard on current production Hobie 16s, these die cast aluminum gudgeons are now available for your Hobie 16, 17 or 18. Their one piece construction and plastic bushed pin holes guarantee pin hole alignment, reducing rudder pin wear, slop and drag.

50102011 H16 EACH



LOCKING GUDGEON SCREWS

No more re-tightening gudgeon screws. As of 1996, Hobie Cat changed gudgeon screws on all new boats to "long lock" screws. Similar to a Nylock Nut, this screw has a nylon insert almost the full length of the threads. The nylon insert screws into the aluminum transom plate and provides the same resistance to movement that the nylock nut does.

8030401 SCREWS, 12-24 LONG LOCK GUDGEON SCREWS
PACK OF 16
8030402 SCREW, 12-24 LONG LOCK
1EA



STAINLESS STEEL RUDDER PINS

Made from 3/8" stainless steel rod, these rudder pins are extremely durable. Sold Each.

20880011 H14,16 EACH
60880011 H18 EACH

STANDARD RUDDER PINS

Sold Each.
10881000 H14 NYLON
20880001 H14/16 ALUM
60880001 H17/18 ALUM



RUDDER CASTING BUSHING

Are you plagued by sloppy rudders? Do your nyliners keep slipping out? Open up the holes in your rudder castings to 7/16" and install these insulating, self lubricating nylon bushings.

8062001 SET OF FOUR

STANDARD HIKING STICKS

See the part diagrams pages for the standard hiking stick to fit your model Hobie.

WAVE HIKING STICK KIT (EZ LOC RUDDERS ONLY)

Add a (tiller) hiking stick to your Hobie Wave! A tiller allows you to hike out or move your weight forward for better down wind speed. Standard tiller and hinge yoke included. For EZ LOC rudder system.

39550001 Wave Tiller Kit



HIKING STICK SOFT GRIP

This soft grip for your tiller extension eliminates "slippery stick". Twelve inches long, made of UV tolerant closed cell foam. Glues on.

3207 FX/Hot STICKS
3206 STANDARD TILLERS



THIRD HAND

This is the closest thing you can get to "self-steering" on a Hobie Cat. This handy little device grips the hiking stick, holding the tiller at whatever position you please. Great for light air sailing or when paddling in if the wind dies. It also keeps the rudders from flopping around when on the beach. Attaches at each end of the traveler track. For the Hobie 14 & 16 only.

204 PAIR

BALL LOCK PINS

Remove hiking stick from the cross bar for trailering or storage without the hassle of unwinding and dropping "ring-dings".

20303 ALUMINUM
20304 HOT STICKS



TILLER CONNECTOR (H20 STYLE)

We've taken the tiller connection system for the Hobie 20 and adapted it to all of the Hobies. Now you can have the no slop, easy adjustment, 10 second assembly/disassembly convenience of the latest in tiller crossbar connection systems. There is no better tiller connection and adjustment available at any price! Now available in a version (1957) for Wave and Getaway (standard on newer boats / non-adjustable). Same easy release system.

1953 PAIR ALL BOATS
1957 PAIR WAVE/GTWY



TILLER CONNECTION KIT

Complete tiller linkage replacement kit. The contoured spacers fit snugly against the tiller end caps and crossbar alignment end cap to eliminate linkage sloppiness without spending a fortune. Includes all required parts.

3052 PAIR

RUDDER CAM KIT

Replace the rudder cam and flared rudder pins with this kit that includes a pair of cams and a pair of binding post screws.

5202 H14/16
5204 WAVE, 17 and up (H18 '86 & up)



RUDDER CAM SISTERSCREWS

Replace your old flared pins with these reusable pins. No more riveting and drilling. These reusable rudder cams with the turn of a screwdriver. Sold by the pair.

5201 H14/16
5203 WAVE, 17 and up (H18 '86 & up)

RUDDER STIFFENING KIT

Beware of imitations! Features special high density polyurethane washers that will last and last. Highest quality components. These washers and stainless steel Nyloc nuts work great to give your rudders that tight fit. Eliminate wobble between rudder blade and upper casting. Don't settle for less—Get the ORIGINAL.

136 KIT



KICK BACK KIT

Returns rudders to locking position quickly and effortlessly. Really great when sailing in weed filled waters. Installs on the existing rudder bolts. Fits all Hobie 14's/16's. Class legal.

1544 KIT

TECH TIP!

RUDDER RAKE

Excessive weather helm (when you must pull hard on the hiking stick to keep the boat from turning towards the wind) can be corrected by cocking the rudders farther (forward) under the boat. If you have too much lee helm (very little pull on the hiking stick, with the boat tending to turn away from the wind), this is corrected by unscrewing the adjustment and cocking the rudders back (aft). The amount of rudder rake needed depends on how far back the mast is raked and how much weight is being carried. The biggest problem with rudder adjustment is when a skipper changes the blade adjustment screw without reseating the cam plate in the upper casting. Even a very minor adjustment to the rudder could cause the cam to lock partially rotated, dramatically reducing the kick-up resistance. That means every time you make a blade rake adjustment, you must also reseat the plate AFTER you have finished adjusting the blade rake. There are three very important adjustments that should be made to the rudder assembly.



1. The rudder rake screw which adjusts blade angle.
2. The cam plate bolt which holds the blade forward.
3. The cam tension screw which adjusts kick-up tension.

When system adjustments are made improperly, the system won't work right. You must follow these steps in order!

1. Lift the rudder arm to unlock the assembly.
2. Using an allen wrench, adjust the rudder rake screw to give the desired rudder blade angle (rake).
3. Make sure that the blade is seated forward against the adjustment screw, loosen the cam plate bolt and lock down the assembly. Slide the plate back a little and then forward as far as it will go up into the cam. Retighten the bolt with a 1/2" socket.
4. Adjust the kick-up tension screw with a screw driver. You can calibrate the tension with a fish scale by making a loop of rope and putting it on the rudder blade about 24" down from the front bolt hole. Hook the scale to the loop and pull. Factory kick-up tension is set between 18-22 pounds.



JIB TRAVELER CARS

For the integrated track crossbar on the Hobie 16! Standard equipment as of late 2005. This jib traveler is constructed of Zytel.

Zytel is made of glass reinforced nylon which results in a very strong material. This resists fatigue and impact failure. Brass traveler bearings for easier movement under load. Includes holes for anchoring traveler and traveler return lines. See H16 parts diagrams for replacement parts.

25232201 PORT
25232211 STBD



LO-PROFILE JIB BLOCK

For the Hobie 16 original SS Tracks. It is a basic swivel cam cleat with roller fairlead and Harken aluminum jaw cammatic, mounted on a stainless steel slide. It self aligns with the angle from which the sheet rope is being held for ease of cleating no matter where the crew is positioned. It's one piece, easy to install, light weight, low profile, interchangeable with left or right side and self aimed at the windward side of the boat. (Tracks vary slightly. May require preying open some tracks slightly)
1075 w/ CAMMATIC

TRENTEC JIB TRAVELER CAR

Provides the super low profile needed with raked back masts. Slides in track easily. Can be used with bullet block shackled to sheet rope lead eye to reduce friction to a minimum. Requires traveler car trim system and sheet rope cam or lance cleat.
1552 H16 PAIR FOR ORIGINAL SS TRACK



1071

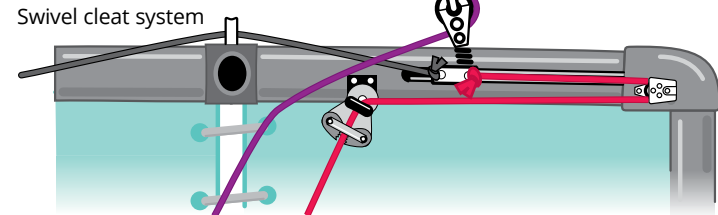

JIB TRAVELER TRIM KIT

These traveler adjustment systems can be used while out on the trapeze. They work with all of the jib cars available. They can both be set up to self return the cars inboard or outboard. Color coded trim lines and all hardware are included. The 1071 kit with swivel cam cleats allow cleating and uncleating from any position on the boat. Lance cleats in the 1073 kit limit the location from which trim lines can be cleated.
1071 KIT W/SWIVEL CAM CLEATS



LANCE CLEATS

The lance cleat utilizes a single rugged aluminum alloy cam mounted vertically in a black molded frame. Just slide the rope sideways and it runs freely in the fairlead, which has a colored roller incorporated in the top for easier sheeting and identification. Ideal for use in confined spaces. For use with 1/4" line. The base size is 1/16" x 15/16". Height is 7/8".
R359S STBD
R359P PORT



ROLLER FAIRLEAD KIT

Simple to install kit converts cleat arrangements that use "bullseye" fairleads to roller fairleads, reducing friction and line chafing. With all hardware. A screwdriver is the only tool needed. Accepts up to 1/2" line.
50012 KIT



SWIVEL CAM CLEAT

Swivel cam cleats feature the Harken Cammatic Cleat. The Cammatic is matched with either the standard bullseye fairlead or the Roller Fairlead. The bullseye fairlead is available with either the plastic jaw Cammatic H365 or the aluminum H150. The roller fairlead is matched with the aluminum jaw H150 Cammatic only.
50007 EYE w/ H365
50009 EYE w/ H150
50013 ROLLERS w/ H150

B323 DEAD EYE



SWIVEL CAM CLEAT

HOLT ALLEN SWIVEL
50017 EACH
11901010 PAD

SWIVEL CAM MOUNTING PLATE

Universal mounting plate for swivel cam cleats. High strength black Delrin® construction that is ultraviolet tolerant.
1161 w/o HARDWARE
1162 w/ HARDWARE



HARKEN CAMMATIC CLEAT

Rounded jaws assure quick cleating/release action and smoother teeth mean longer life for your sheets. Hardkote teflon impregnated die-cast aluminum cams and base with three rows of ball bearings provide a long lasting investment. Use with #50010 Adapter Plate for most change overs.

H150 CLEAT ALUM JAW
1/8" to 1/2" line
H365 CARBON MATRIX JAW
1/8" to 5/16" line
HSB56 REPLACEMENT SPRING
Fits 150/365
H471 MICRO CLEAT, CARBO JAW
1/8" to 1/4" line

Fairleads and eyestraps designed specifically for each Cammatic model, the wedges put the Cammatic on a 15 degree angle for ease of cleating or releasing. The fairleads are molded into a replacement base for each Cammatic. The eyestraps are designed to be held in place over the cams by the mounting screws.

WEDGE KITS

H145 (H150 & H365)

WIRE FAIRLEADS

H284 (H471)

EYESTRAPPS

H137 (H150 & H365)

H201 LOW (H150 & H365)

H281 (H471)



ADAPTER PLATE

Universal mounting plate that allows you to add the Cammatic Cleat to nearly any cleating system now in use. Includes mounting hardware.
50010 KIT

TECH TIP!

BOAT CHECK LIST

There are a number of items to check on your boat. Do this on a regular basis and before sailing for the first time each season. Here are a few of the basics...

STANDING RIGGING (wires)

Check for broken strands. Inspect and slightly bend at all fittings to find broken strands (replace if needed). Check all clevis pins and keepers.

HARDWARE

Check for bent or damaged shackles and other components.

LINES

Check for wear.

HULLS

Check for leaks and possible structural problems. Delamination of the hull structure could lead to major failure.

MAST

Check mast and all aluminum spars for corrosion and other damage. Corrosion can cause structural failure.

RUDDERS

Check the cam lock-down system. This should be free of dirt and sand. Grease regularly to allow free rotation motion.

DRAIN PLUGS!

Need we say more.



H2640



H194

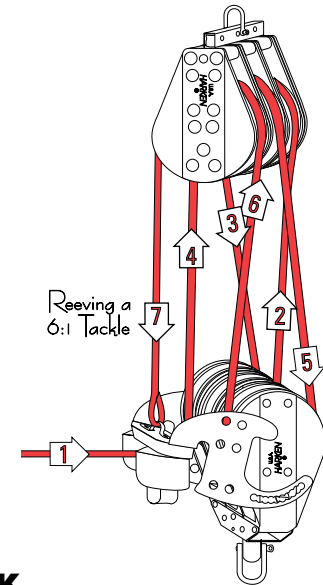

HARKEN 2 1/4" BLOCK LOW PROFILE 6:1

Successful racers have gone to super low profile systems on Hobie 16's (6:1) and 18's (7:1). This allows the sailors to achieve more mast rake for better pointing ability and reduced pitch tendency. They are using the Harken 2 1/4" ratchet block and boom blocks with 3/8" line. The lower block is customized to allow the post to enter the traveler car hinge plate on the Hobie 16. To convert to 7:1, H18 sailors add a mini-block to the eye that's normally used to tie off to and then tie the line off on an empty boom bail.

New Hobie 16s come with H194 Lower ratchet and H2640 Carbo upper.

H2640* UPR 40mm CARBO

H194* LWR 2.25" BLOCK

*use 3/8" sheet rope for smooth flow of line through blocks.

H125 MINI BLOCK (to 7:1)

Note: add 8' to sheet rope length when converting to 7:1 system.

TRAVELER TAMER™

Travel Tamer™ replaces the plastic sheaves on the traveler car with larger, ball bearing rollers to reduce friction.

50014 TAMER



HOBIE CLUB WAVE MAIN TRAVELER KIT

Upgrade any Wave Club model to have a main traveler system. The addition of a main sail traveler will offer better sail control in higher winds and down wind sailing angles. Helps to limit heeling in higher winds while optimizing speed potential. Also reduces loads on the bows, therefore reducing the amount of dive or pitch pole potential. Go faster with better control! Kit includes deep profile traveler track, rivets, #111 brass wheel traveler car, swivel cleat, mount and instructions.

39250000 CLUB WAVE MAIN TRAVELER KIT





HARKEN MICRO BLOCKS

Small blocks with high load capabilities, but light weight. Accepts up to 1/4" line, 1200 pound load, 7/8" diameter sheave.

- H224 SINGLE
- H225 SINGLE w/ BECKET
- H226 DOUBLE
- H227 DOUBLE w/ BECKET
- H228 TRIPLE
- H231 *TRIPLE w/ BECKET & CAM
- H232 TRAVELER (*not shown)
- H233 CHEEK
- H244 FIDDLE MICRO



HARKEN BULLET BLOCKS

Medium size blocks that work well for control line or jib sheeting lines. Accepts up to 5/16" line, 2000 pound load, 1 1/8" diameter sheave.

- H082 SINGLE
- H083 SINGLE w/ BECKET
- H084 DOUBLE
- H092 CHEEK
- H166 SINGLE w/ SWIVEL
- H167 SINGLE w/ SWIVEL & BECKET
- H353 TRAVELER



HARKEN 16MM AIR BLOCKS

Harken's newest small blocks for control lines. Accepts up to 7/32" line, 900 pound load, 5/8" sheave diameter. Ultra light weight.

- H404 SINGLE
- H406 DOUBLE
- H407 DOUBLE W/BCKT

AUTO RATCHET BLOCK

BY RONSTAN

Perfect for spinnaker sheet turning blocks. This Ronstan block is free wheeling at low wind velocity. As the wind velocity increases the pressure on the sheave automatically engages the ratchet. The sheet rope is never trapped in the sheave and can slide out the same as any other ratchet block without first pulling in and then releasing. 55mm sheave.

RF56100 AUTO RATCHET



HARKEN BIG BULLET BLOCKS AND DINGHY BLOCKS

Big blocks accept up to 3/8" line, 2000 pound load, 1 1/2" sheave.

- H125 SINGLE
- H126 SINGLE W/BECKET

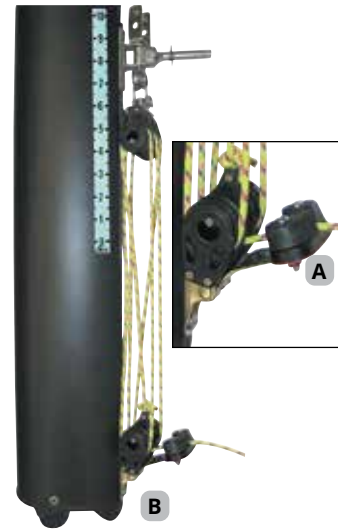

A 6:1 DOWNHAUL KIT

Downhaul system for Hobie 14 and 16. Now Class Legal. Kit comes complete with Harken carbo triple block and triple with cleat. Includes class approved attachment for base of mast, all hardware and line. Use with the gooseneck slide kit # 1511.

2089 6:1 KIT

B DOWNHAUL SCALE

Can you ever remember where the downhaul was set that day you "smoked" everyone. This handy stick on scale takes the guess work out of setting the downhaul.

2082 EACH

POWER PAK

6:1 Downhaul, 2:1 Outhaul systems for Hobie 14 and 16. Rotation control for H14. Jib halyard upgrade for H16.

2090 H14 POWER PAK

2091 H16 POWER PAK



DOWNHAUL/HALYARD SHEAVE

Ease raising the sail and/or adjusting the downhaul with Harken ball bearing sheaves. They really make the job a whole lot easier. A direct replacement for the sheaves that came with the early Hobie 17's.

H160 EACH



HARKEN TRIPLE W/BECKET & CAMMATIC

Perfect for H16 or H17 downhaul.

H231 EACH

H228 EACH



REMOVABLE SHEAVE TRAP RIG BLOCK

This is the block we include in our basic trap rig kits. No need to cut wires to install this block. Simply remove the clevis pin that acts as the sheave axle, slide the sheave out of the frame, place the frame through the trap wire thimble and reinstall the sheave.

3103 EACH

EYE STRAP FOR BOOM VANG

Heavy duty eye strap for connecting boom vang at the mast base rather than at the trampoline slot in the cross bar.

2072 w/ FASTENERS



TRECTEC SUPER GOOSE

Adds convenience and security of attachment to the boom to mast connection. Replace the vertex that connects the boom pin to the gooseneck yoke assembly on the mast. Custom made for the Hobie 18, machined from a block of 6061-T6 aluminum and hard coat anodized. Will not bend and open up no matter how strong the wind. Go a step further and permanently secure the clevis pin that connects that Super Goose to the boom pin with a cotter key. Replace the nut and bolt connecting the vertex to the mast yoke with a 20304 ball lock pin.

1510 EACH



GOOSENECK BEARING

Eliminates drag and prevents gouging the gooseneck slide on Hobie 14, Hobie One-14 (Holder) Monohull and Hobie 16 luff track. Delivers a fantastic improvement in downhaul adjustability!

1511 KIT

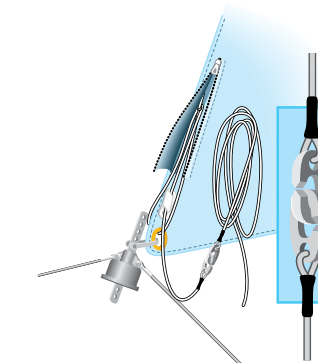

HALYARD GRIP

Keeps those halyards close in to the mast and out of the way so that the jib doesn't hang up on them. Molded from strong Delrin and contoured to the curve of the mast. One on each side of the H16 mast does the trick.

114 EACH w/ HARDWARE



HOBIE 16 "AUSSIE" JIB HALYARD

Reduces mast compression which allows easier tacking, better mast rotation and consistent mast bend! Complete kit includes hardware, 70' (Dyneema® or equivalent) halyard line, zippered pouch, and instructions. Racing class legal.

80660000 KIT



HOBIE "AUSSIE" HALYARD RING

The Aussie Halyard Ring makes engaging and disengaging the halyard hook a real snap. This device helps to keep the ring aligned with the hook. Welded one piece design has a clevis pin that is drilled, so a clevis ring can be added to keep it locked to the sail.

3064 EACH

L'IL SISTER CLIPS

The answer to "What to do with all the jib halyard?" L'il Sister Clip speeds the untie and retie of your H18 jib halyard. Includes both segments of jib halyard.

CM7732 SET



BOW SHACKLE - THREADED PIN

Part # Pin Dia. Width Length Max Ld#
 SP150061 1/4" 9/16" 15/16" 4400



SWIVEL SHACKLE

Complete with clevis & split rings. Align blocks, fittings, etc. B-094 is extra heavy duty.

Part # Pin Dia. Width Length Max Ld#
 B094 1/4" 1/2" 11/2" 1000



"D" SHACKLES - THREADED PIN

Part # Pin Dia. Width Length Max Ld#
 SP150041 5/32" 3/8" 5/8" 1100
 SP150051 3/16" 1/2" 11/16" 2640
 SP150052 3/16" 5/8" 15/16" 2640



SAFETY SHACKLE WITH 1/2 TURN CAPTIVE PIN

Part # Pin Dia. Width Length Max Ld#
 SP185205 3/16" 1/2" 1" 2640
 SP180005 3/16" 5/8" 1 7/16" 2640
 SP180006 1/4" 7/8" 1 5/8" 4400



FAST SHACKLE

The Fast Shackle was created for the jib clew blocks on the Hobie 16 & 18. It's a halyard shackle and an Avibank ball lock pin permanently wired to the shackle so it won't drop in the drink when the blocks are released from the jib clew.

3062 EACH



SNAP SHACKLE

Makes it easy to remove expensive mainsheet systems from your boat when it's parked on the beach or for ease of take down and set up for trailering.

20803 EACH



SPARE PARTS - ALL PACKAGED IN 12" ZIPPERED POUCHES

	Wave/Get	H16	H17
Shackle tool	•	•	•
2 Drain plugs w/gskts	•	•	•
Pair of rudder pins	•	•	•
Clevis pin set	•	•	•
3/16" Bow shackle	•	•	•
1/4" Bow shackle	•	•	•
Mast bearing(s)	•	•	•
3 Batten tie lines	•	•	•
1 Ft. sail repair tape	•	•	•
Part #: 303-	08	06	14

CLEVIS PIN ASSORTMENTS

For Hobie Wave, Getaway, 16 and late model 14. Kit contains appropriate 1/4" clevis pins, 3/16" clevis pin for traveler car, 1/4" clevis pin for mast step link. Split rings are included.

30303 H16/14 SET
 30302 WAVE/GETAWAY SET



KEEPER PINS

Great little helpers for quick rudder removal. Forget the aggravation of straightening those cotter pins! A definite plus for trailering. Stainless Steel.

20501 5/16" DIAMETER
 20502 3/8" DIAMETER
 20503 SAFETY PIN



BALL LOCK PINS

Take the hassle out of rigging and de-rigging your boat. Replace 3/16" and 1/4" clevis pins that use ring dings with easy-to-use push button pins. These "quick pins" are usable in a variety of places on your boat and will not work free by themselves. Use them anywhere a clevis pin can be used! Caution is advised when using these for standing rigging as some inspection or maintenance of the ball lock system may be required to avoid a de-masting.



BALL LOCK PINS

	FSTAY SHRDS	HIKING STICK	OUTHAIL	GOOSE-NECK	TRAVELER CAR	JIB TACK	
20301	3/16"x3/4" Cup Head				14,16,17		
20302	1/4"x3/4" Cup Head		18,21				
20303	1/4"x1 1/4" Ring Hd	Std					
20304	1/4"x1" Ring Head			•			
20305	1/4"x1" Cup Head			•			
20306	#20305 w/Tack shackle & lanyard		20		18,20,21	•	
20307	1/4"x1 1/2" Cup Head	Extendables					
20311	3/16"x3/4" Ring Head	Old H14		•	14,16,17		
20312	1/4"x3/4" Ring Head	•					
20313	3/16"x1/2" Ring Head				14,16,17		
20314	1/4"x1/2" Ring Head	•					
20310	8" X 1/16" Wire Keeper with NicoPress Sleeves						



LIROS MAGIC LINE

The ultimate racing sheet and multi-purpose rope. Stock lines on the Current Hobie 16:

- RLH5BLU** LINE 5MM HERCULES COLOUR BLUE Main Halyard Line (Non-Comtip) 11m / 36.09'
- RLH5RYB** LINE 5MM MAGIC GOLD RED/YEL/BL Traveler Line 4m / 13.12' X2
- RLH5YEL** LINE 5MM MAGIC D PRO YELLOW Jib Halyard (Aussie) Line 21m / 69.9'
- RLH5YRB** LINE 5MM MAGIC GOLD YEL/RED/BL Trapeze Adjuster Line 1.1m / 3.6' X4
- RLM10YEL** LINE 10MM NAUTIC YELLOW Righting Line 5m / 16.0'
- RLM7OW** LINE 7MM MAGIC SHEET ORG/WHT F Jib Sheet Line 10m / 32.81'
- RLM9SW** LINE 9MM MAGIC SHEET SILV/WHT Mainsheet Line 11m / 36.09'
- RLS4BLK** SHOCKCORD 4MM BLACK Jib Traveler Shock Cord .8m / 2.62' X2
- RLS5BLK** SHOCKCORD 5MM BLACK Trapeze Shock Cord 2.1m / 6.8' X2

SUPER LOW STRETCH LINE

For Halyards, Trapeze adjustment and trampoline laces. Pre-stretched polyester line with superior fatigue and abrasion resistance. Our line (3/16"-3/8") tested as the lowest stretch (.5%) of any all polyester line available. Sold per foot.

- RH112WHT** 1/12" WHITE
- RH018WHT** 1/8" WHITE
- RH316WHT** 3/16" WHITE
- RH014WHT** 1/4" WHITE
- RH516WHT** 5/16" WHITE
- RH038WHT** 3/8" WHITE



SPUN DACRON

Best for sheets. Soft matte finish rope. Runs well thru blocks and fairleads, has good abrasion resistance, is spliceable and easy to hold with wet hands. Available in white, black, red, blue. This rope is not designed for winching. Sold per foot. Specify color choice.

- (White, Blue, Red or Black xxx = color)
- RM014WHT** 1/4" WHITE
- RM014XXX** 1/4" COLOR
- RM516XXX** 5/16" COLOR
- RM038WHT** 3/8" WHITE
- RM038XXX** 3/8" COLOR
- RM716WHT** 7/16" WHITE
- RM716XXX** 7/16" COLOR

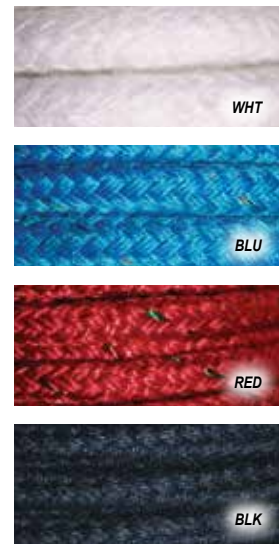

SUPER STRETCH SHOCKCORD

This midnight-black shockcord has double the stretch of ordinary cord. If you've been getting your shockcord from the hardware store, you're in for a treat. The durable black cover is woven around an extra-flexible rubber core.

- RS018BLK** 1/8"
- RS316BLK** 3/16"
- RS014BLK** 1/4"
- RS516BLK** 5/16"
- RS038BLK** 3/8"
- RS716BLK** 7/16"



AMSTEEL

High modulus Polyethylene (aka SK75 Dyneema) 12 strand single braid and is urethane coated for maximum performance. Used for H16 Aussie Halyard. Its tolerance to abrasion is excellent and it is resistant to degradation from ultra violet. This line will also float and has zero water uptake. Color may vary.

8004951 AMSTEEL



ONE WRAP VELCRO®

Cut this double faced Velcro® product to length and wrap it around items, line or whatever you need to secure. One side is hook and the other a loop, so a single piece is all you need.

7904 One Wrap, per foot



SHOCKCORD SNAP HOOKS

Easy to install shockcord snap hook. No tools required. Reusable!

- 2101** HOOK-1/4"
- 2102** HOOK-5/16"



HOBIE TWIST AND SEAL HATCHES

Lids hinge open, so you never lose the lid. A simple twist of the handle opens or closes the hatch. The hatch does not have to be held down against a flat surface to seal. This allows the hatch to seal even if the lid is partially open or tipped. Available in 6" and 8" diameters. * Kits include gaskets and screws (8031131).

- 71701001** 6" TWIST AND SEAL KIT *
- 71701011** 6" TWIST AND SEAL HATCH
- 71321001** 6" MOUNT GASKET
- 71701021** 6" TWIST AND SEAL O RING

- 71702001** 8" TWIST AND SEAL KIT *
- 71702011** 8" TWIST AND SEAL HATCH
- 71331001** 8" MOUNT GASKET
- 71702021** 8" TWIST AND SEAL O RING



HOBIE RECTANGULAR TWIST AND SEAL HATCH KIT

The Horizontal hatch is stiff and strong as designed for standing-on. Unique Hobie designed seal and flange lip drainage keeps water out. Add the optional tackle management tray that deploys two tackle boxes as you open the hatch or the drop-in hatch bucket for versatile small parts storage (both shown below). Includes backing ring. The kit includes the Hatch, gasket, backing ring, screws and instructions.

71707003 HOBIE RECTANGULAR HATCH KIT



HOBIE RECTANGULAR HATCH ACCESSORIES

Add a drop-in "storage box" to your Hobie rectangular hatch or tackle management tray that deploys two tackle boxes as you open the hatch.

- 71709002** HOBIE RECTANGULAR BUCKET
- 71708001** HOBIE TACKLE MANAGEMENT

HOBIE SMALL ROLL TOP DRY BAG

8" diameter x 14". This dry bag is built of tough materials. Seals tight to keep your stuff dry.

71703001 8" HOBIE DRY BAG



VIEW DRY BAG

Transparent 13 oz. vinyl bags make quick work of locating things. Its cylindrical shape will hold various shapes such as clothing, cameras, binoculars, lunches, etc. without distortion of bag and resultant potential leakage. Air purge vent.

- 72210L** VIEW VENTED (10L)
- 72230L** VIEW VENTED (30L)

GUSSETED STOW BAG

Our 6" by 12" gusseted tramp bag rises to the occasion. It has hooks on both ends to clip to your boat and carries the Hobie logo. Also available in 8" x 15" size. Securely stow tool, gloves or small parts for easy access on board your boat.

- 72000B** 6"x12" GUSSETED TRAMP BAG
- 72005B** 8"x15" GUSSETED TRAMP BAG



HOBIE-TRAILEX ALUMINUM TRAILERS

TRAILERS

Anodized aluminum trailers by Trailex, custom designed for Hobie. The best trailers for light weight and long, low maintenance, life.

Getaway / H16 / Tiger trailer (Pictured here) is shown with optional double rollers. Includes forward mast stand. Rollers or cradle attachment hardware is optional. Double roller kit is recommended for Getaway, H16 and similar cats. Cradle attachment kit is recommended for Tiger or other cats to 18' using cradles. Order roller kit, cradle attachment kit and cradles separately. An optional rear mast stand is also shown.

Wave / Bravo trailer has single rollers and carpeted bunk guide pads for the hulls to rest on, does not include a forward mast stand (Optional, order separately).

38653000

TRAILER HOBIE GETAWAY / H16 TIGER / WILD CAT

(Shown with options: rollers, pads and rear mast stand)

38651200

Rear Mast Stand
Optional

NOTE: Loads may require a red warning flag if over hanging lites by over 4 feet.

1 7/8" Coupler

38651000 HOBIE-TRAILEX Trailer WAVE / BRAVO

38651100 FORWARD MAST STAND

38653000 HOBIE-TRAILEX Trailer GETWY, 16, TIGER, WC

38653100 HOBIE-TRAILEX DOUBLE ROLLER KIT

38651200 REAR MAST STAND

Trailer prices DO NOT include freight to dealer or assembly costs.

HULL CRADLES

For hulls, cradles distribute the loads over a larger area of the hull to reduce stresses while trailering or using Cat Trax. (Includes installation hardware to mount the cradles to a 2" diameter tube or roller).

1624 UNIVERSAL SHAPE - pair

38653200 HOBIE-TRAILEX CRADLE ATTACHMENT KIT is required to adapt the Trailex trailer to 2" diameter rollers (4) which enables 1624 cradle attachment / use. For use with 2 sets of 1624 (4) cradles.

HOBIE TIE DOWN STRAPS

Rack tie-down straps, made of durable black polypropylene webbing. Diagonal cut and ironed ends make threading ends into buckles easier.

72042001 TIE DOWNS 12' (Pair)

72043001 TIE DOWNS 15' (Pair)

MK0046 HOBIE CAUTION FLAG



SAIL STORAGE BOX "TOY BOX"

The original Toy Box! Made by roto-molding as one seamless piece with molded-in graphics. Big enough to hold two sets of Hobie sails, booms, daggerboards, rudders and have room left for odds and ends. The bottom is ribbed to allow wet things to drain. There is full access from front and back, even with the boat on the trailer. Mounting hardware is not included. This storage box doesn't care if you sit on it, fill it full of rocks and drop it from 10' or however else you brutalize it. It's tough. Length 10' 4", Width (rear) 21", Depth (rear) 13", Width (front) 19 1/2", Depth (front) 10", Weight 55 lb

Prices DO NOT include freight to dealer.

1825WHT ONE PIECE SAIL BOX



TIE DOWN STRAPS

This outstanding four strap system features patented over center cam action locking buckles coupled with super-strong 2000 lb. test web straps and hooks. The tie downs secure your boat to any trailer in seconds. Full 1 year warranty on all parts. Custom Tie Downs come complete with all mounting hardware and instructions.

1793 H14/16



"ACROSS THE HULLS" TIE DOWNS

One piece tie downs with hooks (and retainers) at each end and paddle handle buckle for easy adjustment. Each tie down is 2" wide by 13' long.

1795 EACH



SHOCKCORD BALL TIES

Lashing the wires to your mast for trailering is quick and easy with this handy tie-down. Use a couple to keep your jib furler on the beach and your sails rolled in the bag. Dozens of other uses.

370 EACH



HOBIE MAST CRADLE

Molded to the shape of the rear cross bar and carpeted to protect the mast and cross bar. Includes a simple single shock cord tie down the secures the cradle to the cross bar and the mast to the cradle. Mast Cradle for Hobie Wave, Getaway, 14, 16, 17, 20 & 21SC

3175

HOBIE MAST STEPPER

This system has a gin pole that rests on a foot attached to the trailer. The mast is stabilized by tying a trap wire on each side to the front cross bar. Attach the trailer's winch (not provided) to the forestay and hoist away. Utilizes bridles to stabilize the gin pole while hoisting the mast.

3152 MAST STEPPER

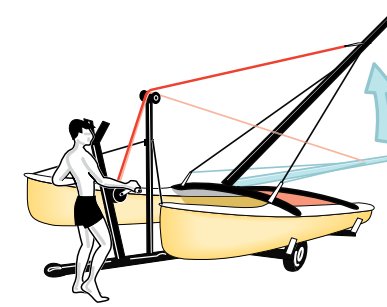

MAST STEPPER II

Easy to install because it eliminates the trailer mounted gin pole. However, the Mast Stepper II system does require that the trailer's forward mast support be 30" taller than the mast step. The mast is stabilized by tying a trap wire on each side to the front cross bar. The kit includes all necessary lines, shackles, blocks and instructions. Purchase winch separately.

3155 MAST STEPPER II

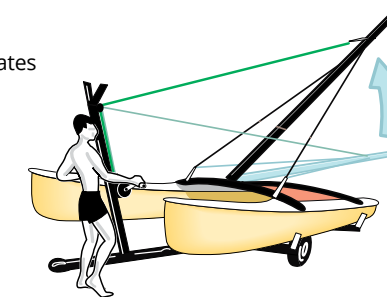

HOBIE MAST STEPPER III

Specifically designed for the Hobie Getaway due to the rotated mast position when stepping. Step your mast with ease and safety. Specially designed bracket attaches to mast at base. A pole plugs into the bracket to create a gin pole arrangement that allows you to singlehandedly raise and lower your mast. It uses the trailer's winch (not provided) for power. Lines snap in place to eliminate side-to-side sway. Attaches quickly without tools. No modifications to boat. Can adjust to fit other rotated-position stepping masts. May also be modified to work on Hobie 17, Tiger and 20 (no instructions are provided for this modification).

3156 HOBIE MAST STEPPER III

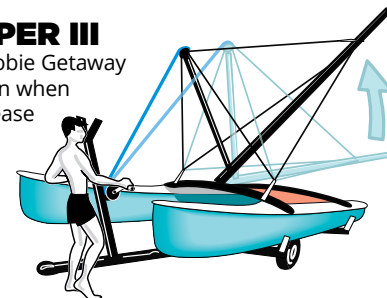

TECH TIP!

Mast Stepping: Usually a two person job. For those days you need help, want to single hand or be able to rig the boat alone for any reason, a mast stepping aid is what you need. The primary function of a mast stepping aid is to raise the mast while restraining side movement induced by a cross wind. Often it is more difficult to handle the side motion than it is to raise the mast. It's the side motion that breaks or bends the hinges and/or mast base castings.



CAT TRAX

CAT TRAX Cat Trax is the dolly for moving catamarans over sand, mud, rocks, or any surface. Lightweight and rustproof. Fast and simple tiedown attachment. Your cat rolls effortlessly on smooth running low friction Delrin® bearings. Jumbo 11" x 21" balloon tires disperse weight, don't dig in on soft surfaces. Tough padded end-caps hold the boat in line. Cradles not included except as noted.

1630 WAVE - 7' BEAM (Includes Axel pad and end caps)

1621 CATS TO 8' BEAM (Includes Axel pad and end caps)

1622 HOBIE 20/21SC (8'6" beam / Requires added cradles)

(H20 add cradles #48010001, All others add cradles #1624)



TRAX

BLUE TRAX The "hard wheeled" version of the all time favorite catamaran beach dolly. Wheels that never need air so they won't go flat. Features the same needle bearings as the Cat Trax. Light weight.

1626 BLUE TRAX (8' BEAM)

1625 BLUE WAVE TRAX (7' BEAM)



HULL CRADLES-BEACH DOLLY

Cradles distribute the boat load over 400 sq. in. of the hull to assure there are no excess stresses while carrying. Fits all popular beach dollies.

1624 UNIVERSAL PAIR



TRAX "T" HANDLE

TRAX ACCESSORIES

1623 T HANDLE - ATTACH TO AXLE (SHOWN ABOVE)

1620 END CAP-EACH

1635 REPLACEMENT CAT TRAX WHEEL ASSY

1636 REPLACEMENT BLUE TRAX WHEEL ASSY

NOTE: ADDITIONAL FREIGHT CHARGE ITEMS
Carts and Trax items shown on this page incur additional freight charges.



H16 Dolly

DOLLY This dolly includes a handle so you can easily slide the cart under the boat and push or pull along holding the handle. Box tube aluminum frame and air inflated tires. Frame has dual contact points / crossbars, so hull is balanced on the cart. (Wheels: *Two / **Four)

90870000 BRAVO DOLLY *

39870000 WAVE DOLLY *

70000111 H16 DOLLY **

TECH TIP!

Boat Covers: Boat covers are designed to protect your boat from UV degradation and dirt. Universal storage covers are one piece and designed for easy installation. They fulfill their purpose mast up (with minor modification) or mast down, on the beach or on the trailer. The fabric is woven polyethylene that is film coated on both sides to cover the woven fabric. It has fantastic tear resistance and is specifically designed for outside use. UV tolerance is one of its major attributes.



UNIVERSAL COVERS Designed to fit a variety of boat lengths, cut into general catamaran shape. It's made of tough woven polyethylene that is coated on both sides, one side silver, one side white. We've chosen this polyethylene because of its excellent resistance to ultra-violet degradation. It is a woven rather than sheet fabric to provide great tear strength. These covers will tolerate sun, wind, rain, high and low temperatures. Install with silver side out.

Each cover is cut to be used for a boat length range. Tapes are sewn in place to allow you to secure the cover around the hulls and crossbars. Custom features such as cut outs or slits for wires or wings can be created with scissors. We include 5 feet of adhesive backed velcro with each kit to be used to prevent openings from flapping in the breeze.

These covers are not designed to be used while trailering.

314-13ALL HOBIE WAVE

314-14TO17 14' TO 16'8" RANGE

314-16-GTWY2 GETAWAY >=2017 / UNIVERSAL

314-17TO18 17' TO 18' RANGE

314-19TO20 H20

DELUXE HOBIE SAIL BAG

Stop fighting with your sail and boom cover. This sail and boom bag zips full length for ease and convenience and will fit any Hobie sail and boom. Full ventilation on each end with vinyl coated mesh. Added convenience with a separate compartment for line and blocks. Made with nylon Cordura®, includes double shoulder straps for maximum ease while carrying. Ends unzip to extend for extra long parts (Color may vary).

3121 DELUXE SAIL BAG

STANDARD SAIL AND BOOM BAG

Pulls over boom and sail like a sock. Open end closes with a drawstring and nylon clasp. Material and color may vary.

21310000 STD 9' 5"

38990050 WAVE



RUDDER COVERS

For your Hobie Cat. Excellent quality. Fastex fasteners keep the rudder covers firmly in place, even when trailering. Protects your rudders from nicks and grime. Sold in Pairs. Style and color may vary.

82420000 ALL BUT 21SE

TECH TIP!

Covers: Protect sails and hardware from sun and abrasion damage. Perhaps the greatest enemy of many modern fabrics is the sun's ultra violet radiation. It deteriorates nylon unless it's specially treated and it attacks dacron sail cloth and weakens it. Fortunately, nylon can be treated to make it UV tolerant and acrylic fabrics exhibit seemingly endless resistance to UV radiation. These sail bags and sail covers can be used to protect your dacron sails from UV radiation damage.

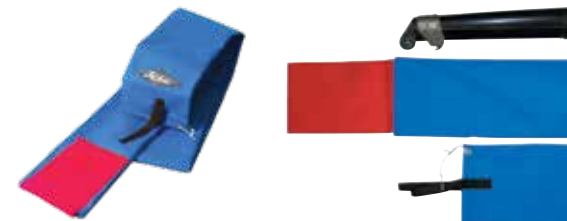

COMPTIP COVER

Hobie Cat recommends that the Comptip portion of the mast be covered to protect it from ultraviolet rays. Our cover is made of UV resistance treated nylon. Ties on to the mast with line that is provided. Fits all Hobie Cats. Will not work with mast floats installed. Royal blue.

3125 COVER- H16/18/20

3127 COVER-H17/21



DAGGERBOARD COVER TIGER/FOX/FXONE

Protect those daggerboards! This two pocket, woven polyethylene lined cover is padded and has a tough, Cordura (600 denier) outer material. It has carrying handles and velcro closures. Very important for preventing dings, gouges, and scrapes while storing and trailering. This is an absolute must for the racer. Room for two daggerboards. Style and color may vary.

72410001 TIGER/FOX/FXONE

SNORKEL JIB COVER

Protect your roller-furled jib from attack by ultraviolet light and the weather. Easy to install and remove—the Snorkel is a must for protecting your expensive sail from eventual destruction by the elements. The Snorkel is a zip-on cover for roller-furled jibs. Made from durable fabric with a full length zipper. Snorkel covers are not intended for long term storage. Jibs must be furled tightly, have luff tension and be secure for windy conditions. Loose jibs and cover may cause chafing damage to sail.



1811 H18/H16/Sport/21S

1812 H14 TURBO/H1-14

1813 H20/H21SE/H18SX

1815 GETAWAY

STICKERS



- 13001001 HOBBIE "FLYING H" BLACK 12 5/8"
- 36601000 HOBBIE "FLYING H" BLACK 6"
- 36601011 HOBBIE "FLYING H" WHITE 6"



- 12451050 "SCRIPT" BLACK 24"
- 12451051 "SCRIPT" WHITE 24"



- 12453031 HOBBIE "TEQ SUNRISE" DOME 4 1/2"



- 79545001 HOBBIE "H" DOME 2 1/4"



- 12453026 HOBBIE SAILING ASSORTED COLORS



- 12453023 HOBBIE CHROME BLACK

SAILORS' ALL PURPOSE TOOL
Handles screws, bolts, and shackles. Wide blade fits up into Hobie Cat's lower rudder castings for adjusting cam spring tension. Narrow blade fits the rudder stop screw and its built in hook is designed specifically to return locked "down" rudder cams to the "up" position with the twist of the wrist.
83103 EACH

EASY RIG Great little temporary handle for halyards, outhauls, downhauls and trampoline tightening. Lay the line in the slot and pull. The line seats in the easy rig handle and provides a handle for tensioning the system. Also available in aluminum from Clamcleat as "Tug Cleat"
2065 UP TO 3/16" LINE
2069 1/4" to 1/2"
2070 TUG CLEAT 1/8"-1/4"

WIRE CUTTER
Do it yourself. Precision designed triangular jaws close and cut. No uneven ends.
83105 EACH

STAINLESS STEEL POCKET KNIFE
DELUXE - Marlin spike, knife blade, shackle tool, and screwdriver. 4.0 oz.
1551 DELUXE

SWAGE-IT TOOL
Make your own wires for those special gadgets you like. Swaging pressure is applied with a box or socket wrench. For 1/16", 3/32", and 1/8" wire sleeves.
83106 EACH

HOG RING PLIERS
Cinch rings, hog rings, upholsterers clamp. They are all the same and these are the pliers to crimp them with. Use them on shockcord.
83104 EACH

GERBER NEEDLENOSE MULTI-PLIER®
Since 1939 Gerber has produced high quality innovative products for the outdoors. Features included in this model are; needlenose pliers, wire cutter, crimper, standard/ metric scale, lanyard ring, cross head screwdriver, bottle/ can opener, serrated sheeps foot blade, large, medium, and small flathead screwdrivers, file, drop point blade, and it adapts to the Gerber Tool Kit! This Multi-Plier® comes with the S.A.F.T. PLUS™ System where each component opens independently of all others, locks tightly against a positive stop roll bar and stays tight until you unlock it. Stainless steel construction with a limited lifetime warranty!
83102 GERBER TOOL

HOBBIE MULTI-LUBE is a planet-safe lubricant recommended for lubricating in-the-water applications. Hobie Multi-Lube offers excellent lubrication, is an anti corrosive coating, great for cleaning and many other uses... use on nearly anything that squeaks, rusts, corrodes or binds up; MirageDrives, rudder drums, cams, fishing reels and more.

The 1 oz size is perfect for getting the lubricant into tight spaces by using the needle applicator. The 4 oz size has a spray applicator for coating chains and larger surfaces, shafts and bulky parts.

- 5120 MULTI LUBE 1 OZ
- 5121 MULTI LUBE 4 OZ

SILICONE SPRAY
Dry silicone spray for cleats, hatch O-rings. (Image above may not represent current packaging or volume)
5107 SILICONE 7oz.

TEAR-AID
Each TEAR-AID® repair patch is made from an exceptionally tough, matte finish, abrasion resistant, elastomer that resists puncture and tearing. It is combined with an aggressive adhesive formulated for high bond strength to a variety of surfaces such as canvas, leather, rubber, nylon, most plastics, paints, aluminum, stainless steel, fiberglass, polyurethane, polyethylene, polypropylene, vinyl and vinyl coated. TEAR-AID® Type A and TEAR-AID® Type B provide a simple and easy method of patching holes and tears, as well as an excellent protective film solution.
72020030 TEAR-AID / TYPE A (POLY)
72020031 TEAR-AID / TYPE B (VINYL)

EACH PATCH KIT CONTAINS: (1) 3" x 12" TEAR-AID® Patch that cuts with scissors to any size, (1) 7/8" x 7/8" Patch, (1) 1 3/8" x 1 3/8" Patch, (1) 12" Reinforcement Filament for repairing tears at edges, (2) Alcohol Prep Pads, (1) Illustrated Instructions and a Product Repair List.

CLEAR SILICONE SEALER
Make sure your hulls are watertight! Clear Silicone seals leaks around all thru-hull fittings such as gudgeons, drain plug housings, tangs, and pylons. Use when re-rievting mast, boom, and crossbar fittings.
376 1.5 oz. TUBE

AQUASEAL MIRAZYME ODOR ELIMINATOR
There's nothing quite like the odor of damp sailing gear left in your car trunk for a couple of days. With one application eliminate those odors from booties, wet-suits, dry-suits and the rest of your gear. A 100% biodegradable product made from a blend of 10 highly specialized, light activated microbial elements. Works by penetrating into pores of fabric, rubber and even hard surfaces to eliminatem odor naturally.
7003 8oz.

HOBBIE UV PROTECTANT
Protect and rejuvenate fiberglass, polyethylene, vinyl and PVC materials. Wipe on, the protectant absorbs into the material and leaves a UV protective layer. Reduce the loss of essential oils and deflect the sun's harmful UV rays. 12 oz.
70060001 HOBBIE UV PROTECTANT

STARBRITE FIBERGLASS COLOR RESTORER
Brings back original color and luster. Removes heavy oxidation, chalking and fading. Protects against future fading. Will not scratch gelcoat. Excellent for all dark colored boats. No hard rubbing is necessary.
1618 16 oz. BOTTLE

STARBRITE POLISH
During the many months of storage, wind can force dirt into the microscopic pores of your hull and leave the surfaces dull and gritty. To prevent this, an application of Starbrite Marine Polish will seal the hull of your boat and insure a bright and shiny surface when spring comes around. Weather resistant protective coating will keep your hull dirt and stain free.
1611 16 oz. BOTTLE

SEA SPRAY TRAMP CLEANER
We've formulated our own trampoline cleaner. It comes in a pump spray bottle so you can apply a light spray to the trampoline, brush and rinse off. It removes dirt, stains, and mildew. Cleans new trampolines and restores old ones.
1619 TRAMP CLEANER

MAGICA RUST REMOVER
Easily clean rust stains from fiberglass, plastic surfaces, metal parts or fabrics. Although metal parts are made from high quality stainless steel, machining tools often leave carbon particles imbedded in the metal surfaces. This material can bleed a rust stain onto other surfaces. Magica simply dissolves the rust away.
1603 MAGICA GEL 8 oz. BOTTLE

FSR Fiberglass Stain Remover, is a unique stain absorbing gel. Ideal for removing oil, rust, exhaust, waterline, and transom stains yet it can also be used anywhere else fiberglass stains may crop up - shower stalls, furniture, etc. Removes road soil. Non-abrasive. Requires no sanding or compounding. Simply apply with a brush, sponge, or cloth, wait a few minutes, then wipe off.
790 ONE PINT



100% POLARIZED SUNGLASSES

EVGLADE-010108



EVGLADE-010168



SNOOK-010108



SNOOK-010168



EVGLADE-010126



EVGLADE-010138



SNOOK-010126



SNOOK-010138



EVERGLADES

- EVGLADE-010108 SATIN BLACK - GREY POLARIZED
- EVGLADE-010168 SATIN BLACK - COBALT MIRROR POLARIZED
- EVGLADE-010126 SATIN BLACK - SEA GREEN MIRROR POLARIZED
- EVGLADE-010138 SATIN BLACK - SIGHTMASTER™ PLUS POLARIZED

SPECS / FEATURES:

Fit: Large; Measurements: 63-18-129 (Eye-Bridge-Temple)
8 Base; Polycarbonate lenses; HydroClean™ 360° Polarized Technology;
TR-90; Integrated hinges; Co-molded megol rubber; Prescription Friendly

BAJA-010139



BAJA-010168



BAJA

- BAJA-010139 SATIN BLACK - SEA GREEN MIRROR POLARIZED
- BAJA-010168 SATIN BLACK - COBALT MIRROR POLARIZED

SPECS / FEATURES:

Fit: Extra Large; Measurements: 64-18-123 (Eye-Bridge-Temple)
8 Base; Polycarbonate lenses; HydroClean™ 360° Polarized Technology;
TR-90; Precision flex hinges; Megol rubber anti-fog rubber gasket;
Prescription Friendly

LIFETIME WARRANTY

NO-HASSLE, FRIENDLY, LIFETIME WARRANTY FOR RETAILERS AND CONSUMERS

Hobie Eyewear sunglasses are warrantied to the original registered purchaser against defects in materials and workmanship for the LIFETIME of the sunglass. Take advantage of servicing your customer directly or sending them to Hobie Eyewear for warranty services. Either way you will receive great, fast, and friendly service. For instances where a manufacturer defect has not occurred, Hobie Eyewear may choose to replace sunglasses under its discretion.

To learn more, visit www.hobieeyewear.com/warranty.

ELMATADOR-010108



ELMATADOR-978138



SLIDE YOUR SIDES

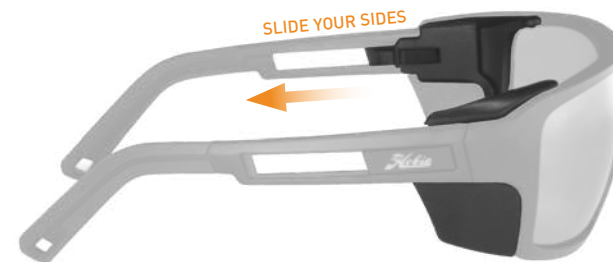

EL MATADOR

Fully integrated coverage from harmful UV light. Protective side shields glide into place when temples arms are extended. Co-molded rubber pads the arms and nose for extra comfort and zero slippage. Perfect for all day kayak excursions and bright days patrolling the southern California coast.

- ELMATADOR-010108 SATIN BLACK - GREY POLARIZED
- ELMATADOR-978138 SATIN BROWN TORTOISE - SIGHTMASTER™ PLUS POLARIZED

SPECS / FEATURES:

Fit: Large; Measurements: 61-15-130 (Eye-Bridge-Temple)
8 Base; Polycarbonate lenses; HydroClean™ 360° Polarized Technology;
Retracting side shields; TR-90; Integrated hinges, Co-molded megol rubber;
Prescription Friendly

MAVERIC-920008



MAVERIC-940027



MAVERICKS

Lightweight and durable memory metal, allows these frames to be bend or twist and return to their original shape.

- MAVERIC-920008 SHINY BLACK - GREY POLARIZED
- MAVERIC-940027 SHINY GOLD - COPPER GRADIENT POLARIZED

SPECS / FEATURES:

Fit: Large; Measurements: 58-15-135 (Eye-Bridge-Temple)
6 Base; Polycarbonate lenses; HydroClean™ Polarized Technology;
Stainless steel; Precision flex hinges; Adjustable silicon nose pads;
Prescription Friendly

MAYWOOD-009208



MAYWOOD-289428



MAYWOOD

- MAYWOOD-009208 SHINY BLACK - GREY W. SILVER FLASH POLARIZED - NEW
- MAYWOOD-289428 SHINY TORTOISE - COPPER W. SILVER FLASH POLARIZED - NEW

SPECS / FEATURES:

Fit: Medium; Measurements: 54-18-142 (Eye-Bridge-Temple)
6 Base; Polycarbonate lenses; HydroClean™ Polarized Technology;
TR-90; Integrated hinges; Prescription Friendly

WOODY-50PGY



WOODY-94PCP



WOODY

- WOODY-50PGY SHINY BLACK - GREY POLARIZED
- WOODY-94PCP SHINY TORTOISE - COPPER POLARIZED

SPECS / FEATURES:

Fit: Medium; Measurements: 56-19-139 (Eye-Bridge-Temple)
6 Base; Polycarbonate lenses; HydroClean™ Polarized Technology;
TR-90; Integrated hinges; Prescription Friendly

WRIGHTS-000008



WRIGHTS-949428



WRIGHTS-141426



WRIGHTS-141458



WRIGHTS

- WRIGHTS-000008 SHINY BLACK - GREY POLARIZED
- WRIGHTS-141426 SHINY CRYSTAL CLEAR - SEA GREEN MIRROR POLARIZED - NEW
- WRIGHTS-141458 SHINY CRYSTAL CLEAR - SUNSET MIRROR POLARIZED - NEW
- WRIGHTS-949428 SHINY BROWN TORTOISE - COPPER POLARIZED

SPECS / FEATURES:

Fit: Medium/Large; Measurements: 54-18-138 (Eye-Bridge-Temple)
6 Base; Polycarbonate lenses; HydroClean™ 360° Polarized Technology;
Signature lightweight floating frame; Integrated hinges; Prescription Friendly

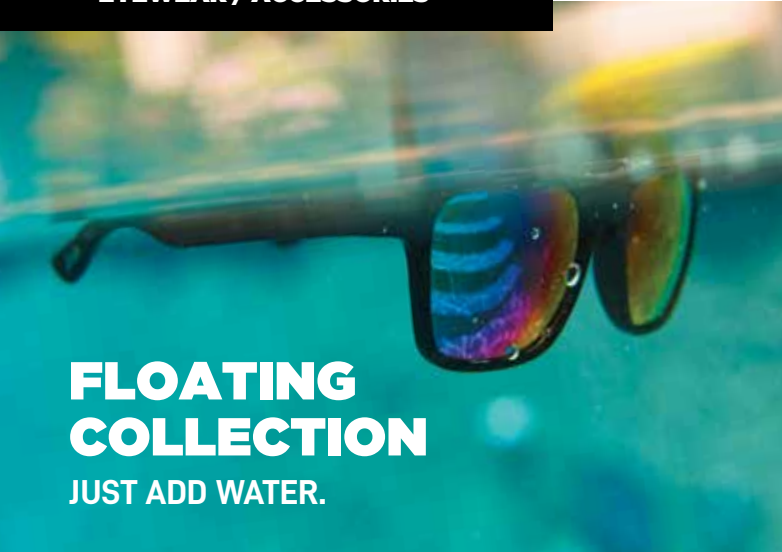

FLOATING COLLECTION
JUST ADD WATER.

IMPERIAL FOLDING FRAME

Imperial can be folded into its included neoprene carrying case for compact storage and portability, and placed into your pocket or clipped onto your equipment.

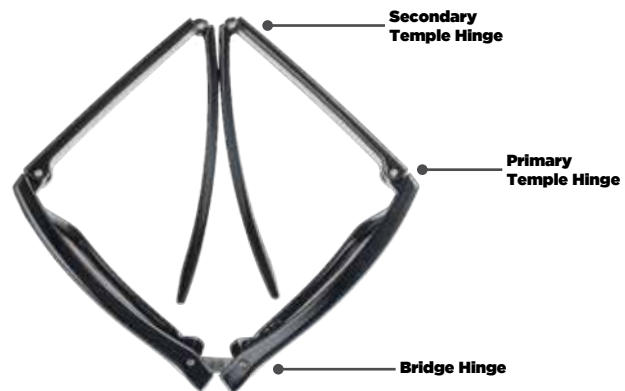

IMPERIAL-000008



IMPERIAL-000068



IMPERIAL-000026



IMPERIAL

IMPERIAL-000008 SHINY BLACK - GREY POLARIZED - **NEW**
IMPERIAL-000026 SHINY BLACK - SEA GREEN MIRROR POLARIZED - **NEW**
IMPERIAL-000068 SHINY BLACK - COBALT MIRROR POLARIZED - **NEW**

SPECS / FEATURES:

Fit: Medium; Measurements: 55-17-136 (Eye-Bridge-Temple)
 6 Base; Polycarbonate lenses; HydroClean™ Polarized Technology;
 Multi-integrated hinges; Megol rubber nose pads; Prescription Friendly



2 in 1

POLARIZED SUNGLASSES & BI-FOCAL READERS:

Be ready to read with this sunglass and bi-focal reader combo. Imperial Sun Reader lenses features a dual 100% polarized lens with discreet reader magnifications at the bottom.

IMPE150-000128 SHINY BLACK - COPPER POLARIZED - +1.50 READER LENS
IMPE200-000128 SHINY BLACK - COPPER POLARIZED - +2.00 READER LENS
IMPE250-000128 SHINY BLACK - COPPER POLARIZED - +2.50 READER LENS



IMPE150-000128
 IMPE200-000128
 IMPE250-000128



HOBIE® QUICK SWAP LENS SYSTEM

BUILD YOUR OWN SUNGLASSES

Adapt to changing light conditions with speed and ease - Huntington's unique design allows to securely swap out Hobie® lenses with the push of your finger.

HUNTINGTON

HUNTING-010199 SATIN BLACK - FRAME ONLY



HUNTING-010199

SPECS / FEATURES:

Fit: Medium/Large; Measurements: 65-18-133 (Eye-Bridge-Temple)
 6 Base; Polycarbonate lenses; HydroClean™ 360° Polarized Technology;
 Integrated hinges, Co-molded rubber; Prescription Friendly

HUNTING-L0108



HUNTING-L0168



HUNTING-L0126



HUNTING-L0138



LENS SELECTION:

HUNTING-L0108 SATIN BLACK - FULL RIM - GREY MIRROR POLARIZED
HUNTING-L0168 SATIN BLACK - FULL RIM - COBALT MIRROR POLARIZED
HUNTING-L0126 SATIN BLACK - FULL RIM - SEA GREEN MIRROR POLARIZED
HUNTING-L0138 SATIN BLACK - FULL RIM - SIGHTMASTER™ PLUS POLARIZED

CATCH & RELEASE

Push temple trigger to release lens. Snap new lens into the frame and close trigger to securely lock in place.



CASE INCLUDED

Pack your lenses away in Huntington's specialized protective hard case with removable storage pockets which can hold up to 2 additional lens sets. Leave no frame behind, secure your case to your equipment anytime with the included carabiner clip.



6507X
Men's Grey L/S
T-Shirt
Hobie Script



5059
Water
Hat, Tan



5042
Lifeguard,
Straw

Apparel, Eyewear & Accessories For Men & Women



5046
Red Red-
fish, Snap

6000
Beach Towel,
Orange

6001
Beach Towel,
Lime

6003
Beach Towel,
Aqua



6506X
Men's Black T-Shirt
Classic Diamond



5047
Bass, Snap



6523X
Baja Stripe Charcoal
PO Hoodie



72026103
Speaqua Bluetooth
Speake



6519X
Fishing Char/
Lime S/S

6502X
Men's Cream T-Shirt
Hobie California Logo

6521X
Unisex Sky Blu
PO Hoodie
Script Logo



6514X
Unisex Burnt Orange Zip Hoodie
California Logo

**OFFICIAL GEAR
FOR LIFE ON THE WATER** hobie.com

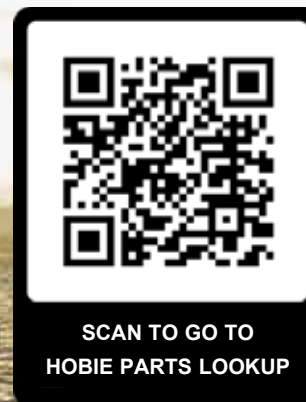

View the complete selection of Apparel, Eyewear and Accessories on hobie.com

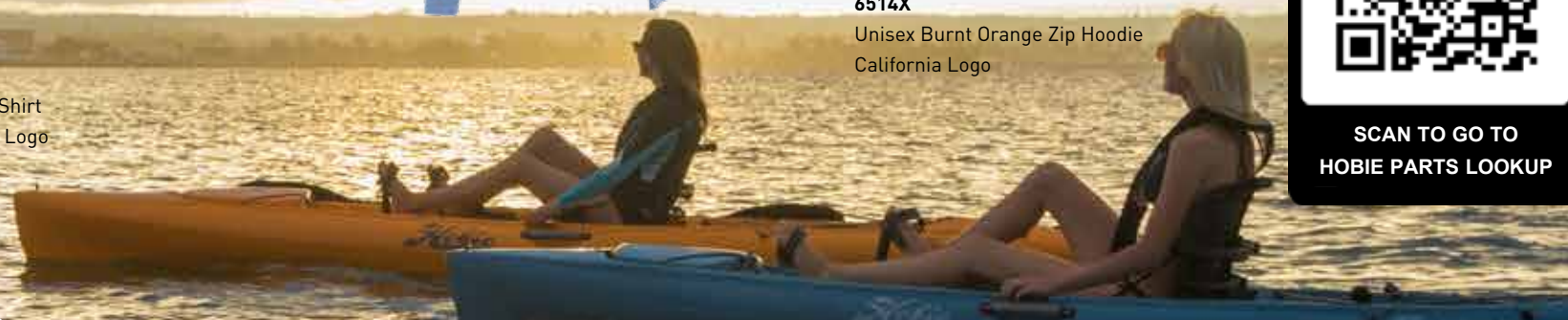

SHROUD ADJUSTER COVERS

Protect hands and feet by covering up sharp edges with these soft vinyl molded adjuster covers. Also great for keeping clevis pin rings from getting snagged and working out of the pin. Sold in pairs.
3261B BLACK, 12" PAIR

WIRE COVERS

Standard wires come with molded covers. If your wires are bare you can cover up with these durable vinyl covers for shroud, trapeze wires, stays, etc. Comes in 6 foot lengths. The H16 and H17 shrouds and forestays are 1/8". The H18 shrouds and forestays are 5/32". Many customers prefer to order the next size larger. They will fit just as well and are easier to install.
3252W 1/8" WHITE
3253W 5/32" WHITE

HOBIE STANDARD MAST BEARING

Package of 3 for the 14 & 16.
11110005 3 BEARINGS

H18 MAST BEARING KIT

For H18. Eliminate that screech when your mast rotates. Get a new bearing with a Teflon™ disk to fit under the bearing.
1132 BEARING & DISK



LICENSE FRAME

3043 "HOBIE" CHROME



HOBIE CROAKIES

Keep your glasses in place! Made from wetsuit fabric that will not stretch or lose shape when wet. Remains secure whether worn normally, raised or lowered around your neck.
1553CR EACH

BARNACLE PLUS BLUETOOTH SPEAKER

Features:

- Waterproof
- Floats
- Stores up to 1,000 songs / 4 GB internal memory
- Industrial suction cup base
- Sand / Dust proof
- Water pressure proof charging port
- Built-in mic & caller ID

Hobie® and Speaqua have partnered up to bring a portable, water-proof speaker into the accessories lineup! This floating, tennis ball sized speaker is both convenient and functional with Bluetooth connectivity, call-taking capability and built-in 4 GB memory for holding up to 1,000 songs. It mounts to any smooth surface using an industrial suction cup base, and is perfect for a sailboat, kayak, SUP or Eclipse.

72026103 SPEAKER BLUE TOOTH AND 4GB

HOBIE-MASTER OF WATER, WIND, AND WAVES

The man, Hobie, known by just one name worldwide, has an epic life story. This 12" x 9" hardcover book shows how it all came to be, and more, in 17 chapters with 300 pages, 120,000 words of text and 585 photographs and illustrations. The book is available through Hobie Cat and Hobie Kayak dealers worldwide.

Surfboards, catamarans and boats, RC model airplanes (the Hobie Hawk), and a whole lot more "toys"—as Hobie himself describes his amazing life's work—will all be celebrated in the biography of the man who defined a lifestyle in surfing and sailing.

87369116 BOOK, HOBIE-MASTER OF WATER, WIND, AND WAVES

STAINLESS WATER BOTTLE

71995001 20oz



hobie.com/support

Instructions, Manuals and all Illustrated Parts Guides including Bravo, Wave, Getaway, H16, H17, H18, Tiger, Wild Cat, Fox, H20, H21SE, Sport Cruiser, Trifoiler, Hobie One/Holder are all available online in our support and parts sections.

hobie.com/forums

Be sure to see the Hobie Sailor forums for online technical help. This includes an FAQ section and many ongoing technical and sailing topics.

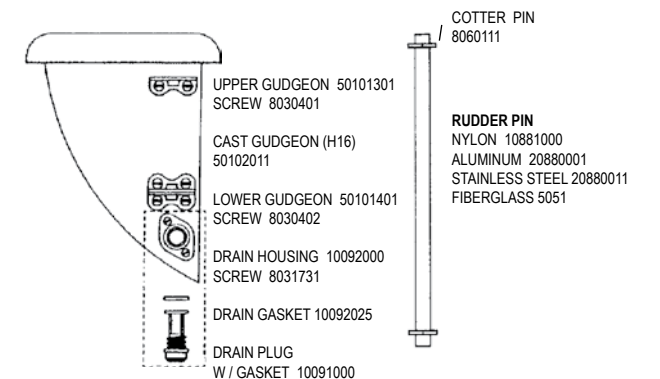
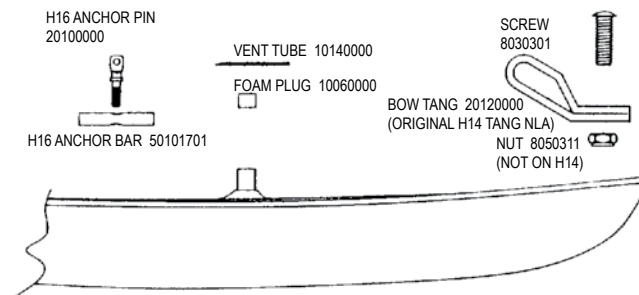

HOBIE CAT PARTS - WARRANTY POLICY

HOBIE PARTS WARRANTY Hobie Cat warrants all Hobie Cat manufactured parts and accessories against failure due to materials or workmanship defects for a period of one year.

OUTSIDE USA WARRANTY INFORMATION - Regions Outside of the USA refer to warranty policy statement issued in each country.

OTHER WARRANTY Any accessories and other merchandise sold by Hobie Cat not mentioned in the paragraph above are not warranted by Hobie Cat. Said accessories and other merchandise may be covered by the manufacturer's warranty, a copy of which can be furnished by Hobie Cat upon written request.

HOBIE CAT'S OBLIGATION Hobie Cat at its option will repair or replace without charge any part or accessory which is found to be defective under the terms and within the period of this Warranty. Buyer must return the accessory with a sales slip as proof of purchase date.

BUYER'S OBLIGATION Upon discovery of a suspected defect, Buyer must-at his/her own expense-promptly return the equipment to the Hobie Kayak dealer for inspection. Warranty is void if equipment is

operated after a suspected defect is, or should have been, discovered.

WHO IS ENTITLED TO WARRANTY Only the original Buyer of the equipment and accessories from Hobie Cat is entitled to warranty. Warranty may not be transferred.

NO WARRANTY OF USED EQUIPMENT Used equipment is sold AS IS; Hobie Cat makes NO WARRANTY concerning its merchantability, condition, durability, age or model year, or fitness for any purpose whatsoever.

MUTUAL AGREEMENTS It is agreed that this warranty sets forth Buyer's exclusive right and remedy against Hobie Cat with respect to the equipment and accessories. It is in lieu of all other express warranties and all implied warranties, including implied warranties of merchantability and fitness. Hobie Cat assumes no other like or unlike liability for loss of cargo, use, profit or consequential damages of any kind in connection with the sale, alteration, use, repair or replacement of equipment or any part thereof.

Hobie

HOBBIE CAT COMPANY
Holding Company
Oceanside, CA, U.S.A.
1-800-HOBIE-49
hobie.com

HOBBIE CAT AUSTRALASIA
Subsidiary
Huskisson, NSW, Australia
1-800-4-HOBIE
hobie.com

HOBBIE CAT EUROPE
Subsidiary
Toulon, France
+33 (0) 494 08 78 78
hobie.com

HOBBIE KAYAK EUROPE
Independent Distributor
Stellendam, The Netherlands
+31 (0) 187 499 440
hobie.com

HOBBIE CAT BRASIL
Independent Distributor
Porto Belo, Santa Catarina, Brasil
+55 (47) 9746-9735
hobie.com



SAILING PARTS & ACCESSORIES

INTERNATIONAL 87367259